

PART VIII--STRUCTURES

Section No.		Page No.
801	General Requirements for Structures	520
802	Structural Excavation and Backfill	528
803	Sheet Piles	535
804	Driven Piles	538
805	Structural Concrete	566
806	Reinforcement	599
807	Structural Metals	606
808	Steel Grid Flooring	648
809	Movable Bridges	651
810	Bridge Railings and Barriers	669
811	Painting and Protective Coatings	672
812	Treated Timber	682
813	Concrete Approach Slabs	688
814	Drilled Shaft Foundations	691
815	Welding	720

Section 801

General Requirements for Structures

801.01 DESCRIPTION. This section sets forth general requirements for construction of bridges and other structures and includes preparation and submittal of shop drawings and other data.

The contractor will be allowed to construct a bridge using any combination of compatible superstructure and substructure details shown on the plans. A precast superstructure may be combined with the compatible cast-in-place bent caps and a precast or cast-in-place concrete barrier rail may be used with the precast slab.

Before beginning construction, the contractor shall notify the engineer in writing as to which alternates are to be used and any deviation will require approval of the engineer.

Any changes in the plans due to combining precast or cast-in-place superstructure with precast or cast-in-place substructure will be the responsibility of the contractor and shall be submitted to the engineer for approval.

Work within wetlands, navigable waters or adjacent areas shall comply with Subsection 107.09.

801.02 BORINGS. Soil borings and other soil investigations and soil analyses will be provided by the Department for development of subsurface information for bridge foundations. This data will be included in the plans for informational purposes. Bidders should make such additional investigations as they consider necessary to determine soil conditions.

If subsurface conditions differing materially from those indicated in the plans are encountered at the site, the contractor shall promptly notify the Engineer in writing of the specific differing conditions before the site is further disturbed and before additional work is performed.

801.03 SHOP DRAWINGS, WORKING DRAWINGS AND OTHER SUBMITTALS.

(a) General: The contractor shall submit shop drawings, working drawings and other submittals for approval. Two prints of required shop or working drawings shall be submitted to the Bridge Design Engineer for checking, one of which will be returned with either approval or required

revisions noted thereon. For final approval and distribution, nine prints of each checked drawing shall be submitted to the Bridge Design Engineer. Sheets shall be assembled in sets and placed in numerical order prior to submittal.

When specified, the contractor shall furnish the consulting engineers in lieu of the Bridge Design Engineer, shop and working drawings for checking, approval, and distribution. A copy of each transmittal letter shall be sent to the Bridge Design Engineer.

No work shall be started until final approval of shop and working drawings has been obtained. No direct payment will be made for required shop and working drawings and other submittals. Review and approval of these drawings and other required submittals will not relieve the contractor of responsibility under the contract.

A shop drawing submittal schedule shall be submitted to the Bridge Design Engineer prior to the preconstruction conference.

Changes on drawings shall be noted and dated to show that a revision has been made.

(1) Drawing Format: Tracings and subsequent reproductions shall have an outside measure of 22 by 34 inches (560 mm by 863 mm) with distance between margins measuring 21 by 31.5 inches (530 mm by 800 mm).

Top, bottom and right margins shall be 1/2 inch (15 mm). Each sheet shall have a title block with the state project number, project name, parish, sheet number, date, and revision block. The title block location and format shall be consistent with the contract plan. If a fabrication plant is involved, the name of the fabricator's plant location will be included in the title block.

a. Original Tracings: Original tracings shall be ink drawings or plottings on polyester translucent matte film 0.004 inch (0.1 mm) thick and have matte surfaces on both sides.

b. Reproductions: Reproductions shall be a black image on opaque white bond paper. The minimum specification for the paper shall be a high quality 24 pound weight with a brightness of 95 percent. The image shall be a permanent type that will not smear or rub off due to normal handling and stacking, and will produce a satisfactory scanned image for archiving. Additions or changes shall be reflected on the final sheet.

(2) Structural Shop and Working Drawings: The control set of structural steel and prestress girder shop drawings will be obtained by the Bridge Design Section from the Construction Section for archiving. The original tracings or reproductions of original working drawings shall be

801.03

delivered to the Bridge Design Engineer upon completion of fabrication or erection.

(3) Other Structures: One set of the final approved shop and working drawings suitable for microfilming shall be delivered to the Bridge Design Engineer upon completion of fabrication or erection.

(b) Falsework: The contractor shall prepare plans for falsework and submit them to the engineer for review. This requirement shall also apply to falsework required for changes in an existing structure for maintenance of traffic. These plans shall be stamped by an engineer currently licensed to practice civil engineering in the State of Louisiana.

(c) Form Drawings: When requested, the contractor shall prepare and submit to the engineer for review, plans for a proposed forming system for cast-in-place concrete. The plans shall be sufficiently detailed to allow a complete evaluation of their adequacy. Plans for deck forms shall include details of the type screed to be used.

(d) Steel Fabrication and Erection: The type, size and procedures for submittal and approval of these drawings shall be as described in Heading (a) of this subsection.

(1) Shop Drawings: The contractor shall furnish shop drawings for steel work for approval. No fabrication shall be started prior to final approval of these plans; however, when the project has separate structures or has been divided into parts to facilitate construction in accordance with the approved construction schedule, fabrication may be started for a separate structure or a particular part when the final shop details applying thereto have been approved and distributed. These details must conform to the general drawings, stress sheets and specifications. No deviations from the approved shop plans will be allowed without written approval. The contractor shall be responsible for correctness of drawings and for shop fits and field connections, even though drawings have been approved.

If the structural steel on the project consists only of expansion dams and bearing assemblies, the contractor will not be required to furnish a final set of corrected drawings.

(2) Erection Drawings: Before starting steel erection, the contractor shall inform the engineer of the method of erection and equipment the contractor proposes to use, which shall be subject to review and approval. The contractor shall prepare and submit for review and approval a key erection diagram and detail erection drawings for the work, all with dimensions and erection marks to properly coordinate erection drawings with shop drawings.

801.03

The contractor shall also submit erection drawings for all continuous span steel units, trusses and other metalwork requiring field splices to the Bridge Design Engineer for review and approval. Drawings shall outline the erection procedure and equipment to be used. These plans shall be stamped by an engineer currently licensed to practice civil engineering in the State of Louisiana.

(3) Stay-in-Place Metal Panels: When stay-in-place metal panels are used, shop drawings will be required illustrating complete details and supports. They shall be accompanied by two sets of design calculations.

(4) Shipping Statements and Shop Bills: The contractor shall furnish the engineer one copy of shipping statements or notices as each shipment of structural steel is made to the project. Weights of individual members shall be shown on shipping statements.

If payment for structural steel is per pound, the contractor shall also furnish the Bridge Design Engineer with three copies of final shop bills for the structural steel, showing the name, piece-mark, and calculated weight for each member. These bills shall include a summary of the weights of structural steel for the project by grades. Shop bills are not required when lump sum payment is to be made.

(e) Movable Bridge Equipment:

(1) Shop Drawings and Erection Drawings: The contractor shall furnish complete detailed working drawings of the machinery houses, operating house, counterweight, including calculations, and machinery and traffic barrier parts and assembly layouts of items to be furnished. Weights of machinery parts shall be shown on shop drawings and may be estimated initially; however, the final shop drawings shall show the correct weights as determined by weighing the fabricated parts. For commercial parts, the manufacturer's weights or certified dimension sheets will be acceptable. Certified dimension sheets of motors, brakes, generators, gasoline engines, limit switches, traffic gates and other such equipment shall be submitted to the Bridge Design Engineer for approval as soon as possible after award of the contract so that the engineer and fabricator will have the information necessary to determine the details of associated parts. Certified dimension sheets shall show complete specifications for equipment furnished.

The contractor shall submit nine copies of certified dimension sheets and detailed manufacturer's description of each piece of equipment and apparatus to the Bridge Design Engineer, one of which will be returned approved or

801.03

with required revisions noted thereon. If revisions are required, the contractor shall submit nine corrected copies for final approval. The name of the project, project number and parish shall be shown on each sheet of every submittal, with indication of any changes noted on the drawings.

Drawings for counterweights shall show dimensions, method of construction and calculations.

A detailed list of commercial machinery and traffic barrier parts installed on the bridge shall be included in shop drawings. The list shall include item number as shown on drawings and the name, ratings, description, service manufacturer, type, model, catalog and serial number of each item.

The type, size and procedures for submittal and approval of shop and erection drawings shall be as described in Heading (a) of this subsection.

If any part of the work not requiring fabrication is so completely detailed that design drawings may serve as working drawings, the contractor will not be required to submit shop drawings for that part of the work, provided the contractor notifies the Bridge Design Engineer in writing that the work is to be performed as shown on design drawings. The contractor shall be responsible for any errors which may be on the plans, and will not be relieved of any responsibility placed upon the contractor by the contract. Shop drawings will be required for fabricated items.

(2) Maintenance and Operation Instruction Booklets: The contractor shall furnish the Bridge Design Engineer six bound copies of a booklet, 8 1/2 by 11 inches (216 by 279 mm) in size, containing descriptive leaflets and drawings covering items of the electrical equipment. This booklet shall include catalog numbers indicated, printed or typewritten statements prepared by the equipment manufacturer covering the proper method of adjusting, lubricating and otherwise maintaining each item, a concise statement of the necessary operating functions in proper sequence, a detailed description of the functions of each item in connection with the various operating steps, reduced copies of conduit and wiring diagrams and drawings of control desk and switchboard. The booklet shall designate each wire and item of equipment by the numbers and symbols used on the drawings.

The contractor shall also furnish the Bridge Design Engineer six bound copies of a similar booklet for mechanical and traffic barrier equipment which shall include lubricating charts showing locations of lubricating fittings and other points of lubrication, recommended types of lubricant, frequency of application and changing of lubricants and reduced prints of the machinery and traffic barrier shop drawings.

Each booklet shall contain the following:

801.03

a. Front Matter: Cover, instructions for normal operation, operation under emergency or adverse conditions, and shutdown; table of contents, list of illustrations; introduction; and safety precautions.

b. Theory of Operation: Theory of operation to the extent necessary for understanding by operation and maintenance personnel.

c. Maintenance Instructions: Cleaning, lubrication, troubleshooting, inspection, performance verification, disassembly, repair, replacement, and reassembly.

d. Parts Lists.

e. List of Special Tools: Name and size of nonstandard tools necessary for proper maintenance and adjustment of equipment, location requiring the special tools, and the proper adjustment.

f. Illustrations and diagrams.

g. Warning Notes: Cautions and warning notes indicating any condition or practice which could result in personal injury or loss of life.

(f) Precast-Prestressed Concrete Girder Spans: The contractor shall furnish complete fabrication and erection drawings. No girders shall be cast prior to approval of these drawings. When precast stay-in-place concrete panels are used, the below requirements will also apply to fabrication drawings. Precast panels shall comply with Subsection 805.14(k).

Fabrication drawings shall include complete details and dimensions of girders, details of proposed casting bed layout and stressing data. For pretensioned members, fabrication drawings should also include method of holding draped strands in place and method and schedule of release of hold-down and strands and appropriate debond strand data.

If details on the girder design drawings are adequate to serve as working drawings, the contractor is not required to submit working drawings. However, the contractor shall submit corrections to plan dimensions due to elastic shortening, shrinkage, girder slope and other causes. The use of design drawings shall not relieve this contractor of any contract responsibilities.

Erection drawings shall show the location of each girder in each span as well as identifying marks for each girder showing its span and location. The date of casting shall be shown on one end of each girder.

The type, size and procedures for submittal and approval of fabrication and erection drawings shall be as described in Heading (a) of this subsection.

(g) Illumination Systems: Detail drawings for lighting standards or high mast towers including all connections, bases, welds, anchor bolts,

801.03

handhole reinforcement, and erection procedures shall be furnished by the contractor for approval.

Electrical system components shall be in accordance with Section 730.

(h) Traffic Signs and Devices: Detail drawings for overhead or structure mounted signs and devices shall be furnished by the contractor for approval. Fabrication or construction shall not be started until drawings have been approved and distributed.

(1) Fabrication and Erection of Overhead and Structure-Mounted Sign Structures: The type, size and procedures for submittal and approval of these drawings shall be as described in Heading (a) of this subsection.

Detailed drawings for fabrication and erection of aluminum and steel parts for overhead or structure-mounted sign structures shall include details of all parts of the sign structure and mounting brackets.

Required dampers for aluminum overhead sign trusses shall be shown on the shop drawings.

Backing details to be used that are not covered by typical details and notes shown on the plans shall be submitted.

(2) Sign Face Details: Sign face details shall be submitted to the Traffic and Geometric Design Engineer for approval. Details shall be submitted on legal size sheets of acceptable quality for sign faces not completely detailed on the plans. Two prints of required sign face details shall be submitted for checking, one of which will be returned with either approval or required revisions noted thereon. Nine copies of prints shall then be submitted and, if approved, shall be distributed. Approval and distribution of these prints shall be required prior to submittal of drawings for fabrication and erection of the corresponding sign structures.

(i) Buildings: Detail drawings, brochures and samples for architectural and mechanical work shall be furnished by the contractor for approval by the Bridge Design Engineer in accordance with the following requirements.

The type, size and procedures for submittal and approval of shop and working drawings shall be as described in Heading (a) of this subsection. No fabrication or erection work shall begin until these drawings have been approved. Brochures and samples shall be furnished in accordance with the project specifications.

Maintenance and operation instruction booklets shall be furnished in accordance with the project specifications.

801.04 TEMPORARY BRIDGE WORKS. The design of all temporary bridge works or temporary bridge alternates shall be the responsibility of the contractor and will be complete and comprehensive, analyzing all geotechnical, hydraulic, and structural engineering facets including all stage and load conditions of the temporary structures. Temporary bridge alternate designs shall be submitted to the Bridge Design Engineer for approval. Guidance on the design and construction of all temporary bridge works is contained in two AASHTO publications: “Guide Design Specifications for Bridge Temporary Works” and “Construction Handbook for Bridge Temporary Works”. The latest edition of these specifications should be followed for design and construction of all temporary bridge works.

Design details, sketches, calculations, or plans submitted by the contractor shall bear the signature and seal of a professional civil engineer currently licensed to practice in the State of Louisiana.

All field welding of temporary works shall be done by certified welders.

Section 802

Structural Excavation and Backfill

802.01 DESCRIPTION. This work consists of removal of all materials necessary for construction of retaining walls and foundations. It shall include furnishing all necessary equipment, dewatering and the construction of all cribs, sheeting, cofferdams, caissons, etc. necessary for execution of the work. It shall also include subsequent removal of cofferdams and cribs, and placement and compaction of necessary backfill. It shall also include wasting of excess excavated material as approved by the Engineer, such that it will not affect the carrying capacity of the channel nor be unsightly.

802.02 GENERAL CONSTRUCTION REQUIREMENTS. Excavations for substructures shall be shored, sheeted, braced or protected by cofferdams where necessary. When footings can be placed in the dry without cribs or cofferdams, backforms may be omitted, with approval, and the excavation filled with concrete to the required elevation of the top of footing. Additional concrete required shall be placed at no direct pay.

Foundations for reinforced concrete box culverts shall be prepared in accordance with Subsection 701.04.

802.03 PRESERVATION OF CHANNEL. Unless otherwise directed, no excavation shall be made outside of caissons, cribs, cofferdams or sheeting. The natural stream bed adjacent to the structure shall not be disturbed. If excavation or dredging is made at the site of the structure before caissons, cribs or cofferdams are in place, the contractor shall, at no direct pay, after the foundation base is in place, backfill such excavation to the original ground surface or river bed with satisfactory material. Material deposited within the area of the stream shall be removed and the stream freed from obstruction.

802.04 DEPTH OF FOOTINGS. Elevations of the bottoms of footings as shown on the plans are approximate. The engineer may order, in writing, such changes in dimensions or elevation of footings as necessary to secure a satisfactory foundation.

802.05 PREPARATION OF FOUNDATIONS FOR FOOTINGS. Rock or other hard foundation material shall be cleaned of loose material and cut to a

firm level, stepped or roughened surface, as directed. Seams shall be cleaned and filled with concrete, mortar or grout to a suitable depth.

When concrete is to rest on an excavated surface other than rock, care shall be taken not to disturb the bottom of the excavation. Final removal of foundation material to grade shall not be made until just before concrete is placed.

802.06 COFFERDAMS AND CRIBS.

(a) General: Cofferdams and cribs for foundation construction shall be designed and constructed by the contractor in accordance with Subsection 801.04, be made as watertight as necessary for proper performance of the work and be carried to adequate depths and heights. Interior dimensions of cofferdams and cribs shall be such as to give sufficient clearance for construction of forms and inspection of their exteriors and to permit pumping outside of forms. Cofferdams or cribs which tilt or move laterally during sinking shall be righted, reset or enlarged to provide the necessary clearance at no direct pay.

When it is impractical to dewater the foundation before placing concrete, the engineer may require construction of a concrete foundation seal of such dimensions as necessary. The foundation shall be dewatered and the balance of concrete placed in the dry. When weighted cribs are used to partially overcome hydrostatic pressure acting against the bottom of the foundation seal, special anchorages such as dowels or keys shall be provided to transfer the weight of the crib to the foundation seal. During placing of a foundation seal, elevation of water inside the cofferdam shall be controlled to prevent flow through the seal. If the cofferdam is to remain in place, it shall be vented or ported at low water level.

When cofferdams are required for deep foundation construction the contractor shall be responsible for the complete design, fabrication, installation, maintenance and removal of the cofferdam system. The contractor shall submit a deep foundation installation plan which includes all design assumptions and computations. The proposed cofferdams and cribs shall be designed taking into consideration all aspects of global, external and structural stability during each stage of construction, and all unbalanced soil, water and construction loadings. The foundation plan, including the geotechnical design, shall be signed and sealed by a professional civil engineer currently licensed to practice in the State of Louisiana. Upon request, the contractor shall provide to the Department, a description of the engineers geotechnical experience.

(b) Protection of Concrete: Cofferdams or cribs shall be constructed so as to protect foundations from damage caused by a sudden stream rise.

(c) Drawings: Drawings for substructure work shall be furnished in accordance with Subsection 801.03. Drawings for cofferdams shall be stamped by an engineer currently licensed to practice civil engineering in the State of Louisiana and shall include two copies of design computations showing design water levels, soil and water pressures, and all other loads and factors included in the design.

(d) Removal: Cofferdams or cribs with all sheeting and bracing shall be removed after completion of the substructure. Care shall be taken not to damage concrete. No sheet piling used as forms shall be removed prior to 7 days after placement of concrete. Timber from cofferdams or cribs shall not be left embedded in substructure concrete.

802.07 DEWATERING. Excavations below the groundwater table will require ground water control to permit construction in the dry and maintain stability of the excavation base and sides. Controlling seepage may be accomplished by individual or a combination of methods such as sheeting, sumps, or well point systems. The contractor shall submit his method of dewatering in writing to the engineer for approval. Prior approval by the engineer shall not release the contractor from his responsibility to protect the work or to modify his dewatering operation to accomplish its intent regardless of prevailing conditions. All dewatering wells including well points shall be installed and properly abandoned by DOTD-licensed water well contractor, in accordance with the requirements of Louisiana Water Well Rules, Regulations and Standards, a copy of which may be obtained from DOTD's Water Resources Section. All dewatering operations shall be at no direct pay unless otherwise specified in the contract.

(a) Cofferdams and Cribs: Pumping from the interior of a foundation enclosure shall be done in such manner as to preclude the possibility of movement of water through fresh concrete. No pumping will be permitted during placement of concrete or for at least 24 hours thereafter unless done from a suitable sump separated from the concrete work by a watertight wall or other effective means.

Pumping to dewater a sealed cofferdam shall not begin until 72 hours after placement of concrete seal unless otherwise directed.

(b) Well Point System: When required by plans or the engineer, a well point system shall be designed, detailed, installed, maintained and removed by

the contractor. The well point system shall be installed around the perimeter of the excavated area in a location such that other operations will not be impeded. The well point system shall be capable of continuously maintaining the piezometric level in the soil at least 5 feet (1.5 m) below the bottom of the excavated area.

Prior to installation, the contractor shall submit 5 copies of his design calculations and detail drawings of his well point system to the engineer; however, the contractor shall be solely responsible for the adequacy of the well point system.

The contractor shall install piezometers or other suitable means of monitoring within the excavated area as required by field conditions. The contractor shall make daily readings or measurements of the piezometer to verify that the well point system is operational. Excavation may begin when the piezometric level is 5 feet (1.5 m) below the proposed excavation bottom surface for at least four hours.

The well point system shall have a back-up system of pumps and power units. If failure of the well point system occurs, water shall be added to the excavation as rapidly as possible. The dewatering system shall be repaired at the contractor's expense.

(c) Removal: After having served their useful purpose, all temporary dewatering devices and/or temporary protective works shall be completely and satisfactorily removed so as to not interfere, in any way with the operation, usefulness and stability of the permanent structure.

802.08 EXCAVATION OF FOUNDATION. After each excavation is completed, the contractor shall notify the engineer. No concrete shall be placed until the engineer has approved the depth of excavation and character of foundation material.

802.09 BACKFILL. Backfill material shall be of acceptable quality, free from large or frozen lumps, wood or other foreign material.

(a) For backfilling cofferdams and cribs, all spaces excavated and not occupied by piers or other permanent work shall be backfilled with soil to the surface elevation of surrounding ground in such manner as to maintain approximately the same elevation on each side.

(b) Backfilling of Reinforced Concrete Box Culverts: Material and backfilling requirements for reinforced concrete box culverts and attached headwalls shall be in accordance with Subsection 701.08.

Adequate cover shall be provided over reinforced concrete box culverts before heavy construction equipment may cross the installation to prevent damage to the box culvert.

(c) Backfill material for footings shall be placed in horizontal lifts and compacted to the satisfaction of the engineer. The excavation shall be pumped as dry as possible before backfill material is placed.

(d) Backfill for structures other than in Headings (a), (b) and (c) above shall be placed in horizontal layers not exceeding 9 inches (225 mm) loose thickness and uniformly compacted by approved methods to the satisfaction of the engineer. Jetting of backfill behind abutments and wingwalls will not be permitted. The excavation shall be pumped as dry as possible before beginning backfilling.

(e) No backfill shall be placed against a concrete abutment, wing wall or reinforced concrete box culvert until concrete has been in place a minimum of 14 calendar days, or until test cylinders made in accordance with DOTD TR 226 and tested in accordance with DOTD TR 230 have obtained a minimum compressive strength of 3,000 psi (20.7 MPa).

802.10 MEASUREMENT. The quantity of structural excavation for payment shall be the number of cubic yards (cu m), measured in its original position, of material acceptably excavated in conformity with the plans or as directed. No volume shall be included in the measurement outside of a volume bounded by vertical planes 18 inches (450 mm) outside of and parallel to neat lines of footings. The cross-sectional area measured shall not include water or other liquids but shall include mud, muck and other similar semi-solids. No measurement will be made of excavation required for construction of abutment bents or abutment footings. Measurements for intermediate bents or pier footings will be made on the basis of the depth taken from the elevation of the completed sections or natural ground line, whichever is lower, to the bottom of footing; however, no measurement will be made for material not excavated.

(a) Reinforced Concrete Box Culverts: Excavation and backfill required for box culvert construction will not be measured for payment, except as specified in Subsection 203.15.

(b) Cofferdams: When the contract does not contain an item for "Cofferdams", the cofferdams and cribs will not be measured for payment.

When an item for "Cofferdams" is included in the contract, the cofferdams will be measured on a lump sum basis.

(c) Well Point System: When the contract does not contain an item for "Well Point System", the contractor may use any approved method to control the seepage water as required within the specifications. The "Well Point System" will not be measured for payment.

When an item for "Well Point System" is included in the contract, the dewatering system will be measured on a lump sum basis.

802.11 PAYMENT. Payment for structural excavation will be made at the contract unit price per cubic yard (cu m), which includes constructing and removing cribs, sheeting and cofferdams, required excavation and backfill, and disposal of excess excavated material.

If the engineer orders foundations to be lower than the specified elevation, payment for the additional excavation required will be made in accordance with Table 802-1.

**Table 802-1
Payment for Additional Excavation**

Depth of Foundation Below Specified Elevation		Percent of Contract Unit Price for the Excavation Item
Feet	Meters	
0 to 2.0	0 to 0.5	100
2.1 to 4.0	0.51 to 1.0	125
4.1 to 6.0	1.01 to 2.0	150
6.1 to 8.0	2.01 to 2.5	175
8.1 to 10.0	2.51 to 3.0	200
Over 10.0	Over 3.0	Extra Work

When an item for "Cofferdams" is included in the contract, payment for cofferdams will be made at the contract lump sum price, which includes furnishing and installing all materials, backfilling, dewatering, maintenance, removal, and satisfactory clean-up of the areas.

When an item for "Well Point System" is included in the contract, payment for the dewatering system will be made at the contract lump sum price, which includes furnishing, installing, maintaining and removing all materials, equipment, tools, labor and incidentals necessary to satisfactorily control the seepage water.

802.11

Payment will be made under:

Item No.	Pay Item	Pay Unit
802-01	Structural Excavation	Cubic Yard (Cu m)
802-02	Structural Excavation for Intermediate Bents	Cubic Yard (Cu m)
802-03	Structural Excavation for Piers (Dry)	Cubic Yard (Cu m)
802-04	Structural Excavation for Piers (Wet)	Cubic Yard (Cu m)
802-05	Cofferdams	Lump Sum
802-06	Well Point System	Lump Sum

Section 803 Sheet Piles

803.01 DESCRIPTION. This work consists of furnishing and driving sheet piling of the specified type in accordance with the plan details and these specifications. Applications are as follows:

(a) Plan Sheeting:

(1) Permanent Sheeting: Where required by the plans, permanent sheeting shall be of the design shown in the contract plans. Sheeting shall be new and shall receive corrosion protection in accordance with Subsection 803.06.

(2) Temporary Sheeting: Where contract plans require sheeting to facilitate the sequence of construction and to support traffic carrying facilities, the contract plans will specify the required design parameters for sheeting. The contractor shall be responsible for the design and details of the sheeting. Temporary sheeting design and details shall be submitted to the Bridge Design Engineer for approval. Sheeting may be new or used and will not require corrosion protection. Typically, temporary sheeting should be removed when no longer required; however, when impractical to remove or when required in the plans, shall remain in the completed work.

(b) Construction Sheeting: Sheeting used at the contractor's option shall be in accordance with Section 802. The contractor shall be responsible for the design and details of the sheeting. Sheeting may be new or used, does not require corrosion protection, and shall be removed unless otherwise approved.

803.02 MATERIALS. Materials shall comply with the following Sections and Subsections.

Concrete	901
Coal Tar Epoxy-Polyamide Paint	1008.04
Reinforcing Steel	1009
Sheet Piles	1013.10
Timber and Preservatives	1014
Hardware	1018.08

(a) Concrete Sheet Piles: Concrete sheet piles shall be precast-prestressed piles fabricated in accordance with Subsection 805.14.

803.02

(b) Metal Sheet Piles:

(1) Steel Sheet Piles: Steel sheet piles shall be fabricated in accordance with Section 807.

(2) Aluminum Sheet Piles: Aluminum sheet piles shall have a depth of 2 1/2 inches (60 mm) to 6 inches (150 mm), a width of 1.00 foot (300 mm) to 1.67 feet (500 mm), and a nominal thickness of at least 0.125 inch (3 mm). Sheet piles shall have sand-tight interlocking joints.

(c) Timber Sheet Piles:

(1) General: Piles shall be provided with tongues and grooves of suitable proportions, either cut from the solid material or made by building up the piles with three planks fastened together. Piles shall be drift-sharpened at their lower ends to wedge adjacent piles tightly together during driving. Hardware shall be galvanized.

(2) Treated Timber: Treated timber shall be either Southern Pine or Douglas Fir complying with Section 812.

803.03 DRIVING SHEET PILES. Sheet piles shall be driven with hammers adequate to drive the piles to required depth in satisfactory condition. To maintain satisfactory alignment, sheet piles shall be driven in increments of penetration necessary to prevent distortion, twisting out of position or pulling apart at interlocks. If a vibratory hammer is used, the contractor will assume full responsibility for any damage to adjacent structures or for embankment settlement caused by his operation.

803.04 JETTING SHEET PILES. Use of jets will require written approval of the engineer. When approved, jetting will be at no direct pay.

803.05 CUTOFFS.

(a) Tops of sheet piling shall be cut off or driven to a straight line at the elevation indicated on the plans or as directed.

(b) If heads of sheet piles are appreciably distorted or otherwise damaged below cut-off level, damaged portions shall be removed and replaced at no direct pay.

(c) Tops of timber sheet piles after cut-off shall be treated in accordance with Subsection 812.06, except that galvanized metal coverings shall be bent down at least 3 inches (75 mm) on each side and nailed to the vertical surface of sheet piles with large-headed galvanized roofing nails.

(d) Sheet piles damaged during driving, or driven out of proper position or below cut-off elevation, shall be withdrawn and replaced with new piles at no direct pay.

803.06 PAINTING. Temporary and construction sheeting will not require painting unless otherwise specified. Before driving, surfaces of steel sheet piling shall be cleaned and painted from the top of the sheet pile to a point 10 feet (3 m) below the ground or mud line. Paint system to be a 2-coat coal tar epoxy-polyamide in accordance with Section 811.

803.07 MEASUREMENT. Quantities of permanent sheet pile wall for payment will be the design wall area as shown on the plans. Permanent sheet pile design quantities will be measured in square feet (sq m) and be adjusted if the engineer makes changes to adjust to field conditions, if plan errors are proven, or if design changes are made. Temporary sheeting will be measured on a lump sum basis. Construction sheeting will not be measured for payment.

803.08 PAYMENT. Sheeting for cofferdams will be paid in accordance with Section 802. Payment for permanent sheet pile wall and temporary sheeting will be made at the contract unit prices under:

Item No.	Pay Item	Pay Unit
803-01	Timber Sheet Pile Wall	Square Foot (Sq m)
803-02	Concrete Sheet Pile Wall	Square Foot (Sq m)
803-03	Steel Sheet Pile Wall	Square Foot (Sq m)
803-04	Aluminum Sheet Pile Wall	Square Foot (Sq m)
803-05	Temporary Sheeting	Lump Sum

Section 804 Driven Piles

804.01 DESCRIPTION. This work consists of furnishing and driving foundation piles of the type and dimensions designated on the plans to the required penetration, including cutting off or building up foundation piles when required.

804.02 MATERIALS. Materials shall comply with the following Sections and Subsections.

Precast Concrete Piles	805.14
Concrete	901
Coal Tar Epoxy-Polyamide Paint	1008.04
Reinforcing Steel	1009
Steel H Piles	1013.09
Steel Pipe Piles	1013.11
Timber Piles	1014

804.03 CAST-IN-PLACE CONCRETE PILES. Cast-in-place concrete piles shall be steel encased. Steel shells shall be of the specified diameter and type. Shells for cast-in-place concrete piles shall be of sufficient thickness and strength so that the shell will hold its original form and show no harmful distortion after it has been driven. It shall be the contractor's responsibility to determine the required shell wall thickness. The shell shall be filled with Class A concrete and placed in accordance with Section 805. The DOTD Chief Construction Engineer shall approve use of concrete other than Class A. When reinforcing steel is required, it shall comply with Section 806.

804.04 PILE LENGTHS. The contractor shall furnish piles in accordance with an itemized order list, which will be furnished by the engineer showing the number, size, length and location of all permanent piles. No permanent piles shall be fabricated prior to receipt of this order list. The lengths given in the order list will be based on the lengths that are assumed after cutoff to remain in the completed structure. At the contractor's expense, the pile lengths shall be increased to provide for fresh heading and for such additional length as may be necessary to suit the contractor's method of operation. When test piles or indicator piles are required, the pile lengths shown on the plans are for

estimating purposes only. The approved order list will not be furnished to the contractor until the test piles or until indicator piles have been driven, tested, and analyzed. The engineer may revise the order length when driving conditions deviate from the test pile or indicator pile results.

804.05 PILE DRIVING SYSTEM SUBMITTAL AND APPROVAL.

(a) Submittals: A description of the proposed pile driving system, which includes the pile driving equipment to be furnished by the contractor and the method of pile installation, shall be submitted in the form of a Pile Installation Plan for approval by the DOTD Chief Construction Engineer. The pile driving equipment and the pile installation method shall be such that piles will obtain the required penetration without damage. In no case shall the pile driving equipment be transported to the project site until approval is received in writing. As a prerequisite to such approval, the contractor shall submit the Pile Installation Plan at the preconstruction conference and/or no later than 30 calendar days prior to driving piles. The engineer will evaluate the Pile Installation Plan for conformance with the plans and specifications. Within 20 calendar days after receipt of the Pile installation Plan, the engineer will notify the contractor of any additional information required and/or changes that may be necessary in the opinion of the engineer to meet the plans and specification requirements. Any parts of the contractor's submittal that are unacceptable will be rejected and the contractor will resubmit changes agreed upon for reevaluation. The engineer will notify the contractor, within seven calendar days after receipt of proposed changes, of their acceptance or rejection. The time required for submission, review, and approval of a revised pile driving system shall not constitute the basis for a contract time extension by the contractor. All approvals given by the engineer shall be subject to trial and satisfactory performance in the field. The contractor shall use the approved pile driving system during pile driving operations. The contractor shall make any required changes, including supplying additional hammers, that may result from unsatisfactory field performance. Final acceptance will be given after necessary modifications are made. No changes in the driving system or installation method may be made after final approval without the written approval of the DOTD Chief Construction Engineer.

(b) Driven Pile Installation Plan: The pile installation plan shall provide detailed information pertaining to the pile driving equipment and the method of pile installation. The submittal should include the following information:

804.05

(1) Pile and Driving Equipment Data Form. The Department shall supply this standard form. The contractor shall complete the form with the proposed pile driving equipment for each unique pile driving system that will be used on the project. When a hammer cushion or pile cushion is composed of differing materials with varying properties the contractor shall provide a detailed description of the composite cushion. Composite cushion descriptions shall include material type, layout, and thickness of each cushion component.

(2) A list detailing the type and size of the proposed pile driving equipment, including hammer, leads, jetting equipment, compressors, and drilling equipment for preboring. Include hammer manufacturer's operating manual and compressor data sheets. If a mandrel is used to install piles, a complete description shall be provided including size and weight of components.

(3) Proposed pile driving methods that may be required to facilitate pile driving installation such as preboring or jetting.

(4) Methods to determine hammer energy in the field for determination of the pile bearing capacity. When pressure measuring equipment will be used to determine hammer energy, the submittal shall include hose length, hose diameter, equivalent energy charts, and calibrations.

(5) Detailed drawings of any proposed followers.

(6) Detailed drawings of templates.

(7) Required shop drawings for pile splices, shoring, sheet piling, cofferdams, etc.

(8) Pile driving sequence for each unique pile layout configuration.

(9) Details of proposed static load test system, equipment, and procedures in accordance with Subsection 804.11. The load test system details shall include information pertaining to ground excavations or casings, bearing plates, layout of reaction piles, reaction beams, deflection monitoring reference beam, etc. The load test equipment details shall include jack size, length of jack hose, and type of deflection monitoring instrumentation to be used. General load testing procedures should be provided concerning loading increments, sequence of loading, etc. If a load cell is required, calibration and load cell information shall be submitted.

(10) Proposed schedule for test pile and/or indicator pile program and production pile driving.

(11) Details of the access system for attaching instrumentation for dynamic monitoring.

(12) Other information shown in the plans or required by the engineer.

(c) Pile Driving Equipment Approval: Unless shown otherwise in the plans or directed by the engineer, the approval of the pile driving system shall be made by the Hammer Approval Method shown in Table 804-1. This approval shall be based on the contractor's proposed pile driving equipment and pile installation method.

If the Hammer Approval Method is used, the engineer will evaluate the contractor's proposed pile driving system in accordance with the requirements stated herein for the minimum hammer rated energy. The Wave Equation Hammer Approval Method may be substituted for the Hammer Approval Method if pile driving problems arise after approval with the Hammer Approval Method or when, in the opinion of the engineer, a more rigorous method of analysis is required to review the contractor's proposed pile driving system. The Hammer Approval Method shall not be used if the required end-of-driving pile capacity is greater than 300 tons (2650 kN).

(1) Hammer Approval Method: The Hammer Approval method is based on the required end-of-driving pile capacity, hammer type, and the minimum required hammer rated energy. Table 804-1 provides the minimum Manufacturer's Rated Hammer Energy that is required. The Manufacturer's Rated Hammer Energy shall be based on the theoretical potential energy of the ram at impact.

Table 804-1
Hammer Approval Method
Minimum Manufacturer's Rated Hammer Energy

End-Of-Driving Pile Capacity		Minimum Manufacturer's Rated Hammer Energy			
(tons)	(kilonewtons)	(ft-kip)		(kilojoules)	
		ECH*	Diesel	ECH*	Diesel
≤ 60	≤ 535	6	8	8	11
80	710	8	11	11	15
100	890	11	14	15	19
120	1070	13	17	18	23
140	1245	16	21	22	29
160	1425	20	24	27	33
180	1600	24	29	33	39
200	1780	29	34	39	46
220	1960	35	40	48	54
240	2135	43	47	58	64
260	2315	52	57	71	77
280	2490	59	67	80	91
300	2670	64	74	87	100

* ECH = External Combustion Hammers

(2) Wave Equation Hammer Approval Method: Approval of the contractor's pile driving equipment will be based on the wave equation analysis computer program (FHWA-WEAP87 or newer version) and as required elsewhere in this subsection. A wave equation analysis will be performed by the Department for each pile type and size required in the plans. Approval of the pile driving system does not relinquish the contractor's responsibility from driving the piles to the required pile tip elevation without damage.

The criteria the engineer will use to evaluate the pile driving equipment from the wave equation shall be the pile driving resistance. The required number of hammer blows at the required end-of-driving pile capacity shall be from 36 to 146 blows per foot (30 to 120 blows per 0.25 m). The pile driving resistance at any depth above the required pile tip elevation shall be achieved with a reasonable driving resistance of less than 300 blows per foot (250 blows per 0.25 m).

Additional criteria that the engineer will use for the pile driving equipment to be acceptable are the pile driving stresses that are indicated by the wave

equation analysis to be generated during pile driving. The pile driving stresses shall not exceed the allowable values as required in Subsection 804.08(g).

When the wave equation analysis shows that the contractor's proposed equipment or methods will result in either the inability to drive the pile with a reasonable driving resistance to the desired pile bearing capacity or will exceed the maximum allowable pile driving stresses, the contractor shall modify or replace the proposed methods or equipment at his expense until subsequent wave equation analyses indicates that the contractor's proposed pile driving equipment and driving methods meet the required criteria for acceptability stated herein.

804.06 PILE DRIVING EQUIPMENT.

(a) Hammers: Piles may be driven with either diesel hammers or external combustion hammers (ECH) such as hammers driven by steam, air, or hydraulic power. Non-impact hammers such as vibratory hammers shall not be used unless specified in the plans or permitted in writing by the engineer. Hammers shall be rated based on the theoretical potential energy of the ram at impact.

A variable energy hammer shall be used to drive precast concrete piles.

(1) Steam and Air Hammers: Steam and air hammers that are used to drive precast concrete piles shall be capable of providing at least two ram stroke lengths. The short ram stroke length shall be approximately half of the full stroke. Reductions in steam or air pressures to produce reduced hammer strokes will not be permitted. In lieu of a variable energy hammer, the contractor may propose in the Pile Installation Plan the use of multiple hammers of different rated energies to drive precast concrete piles.

The plant and equipment furnished for steam and air hammers shall have sufficient capacity to maintain the hammer at the volume and pressure specified by the manufacturer. The plant and equipment shall be equipped with accurate pressure gauges that are easily accessible for viewing by the engineer. The weight of the striking parts of air and steam hammers shall not be less than 1/3 the weight of drive head and pile being driven, and in no case shall the striking parts weigh less than 2,750 pounds (1250 kg).

(2) Open-End Diesel Hammers: Open-end diesel hammers used to drive precast concrete piles shall be capable of providing a selection of at least three fuel settings that will produce varying stroke lengths.

The contractor shall provide the engineer a chart from the hammer manufacturer equating stroke in feet (m) and blows per minute. The

804.05

contractor shall have available on-site an approved device to determine and display ram stroke in feet (m) of an open-end diesel hammer.

The device used to determine the hammer stroke shall be periodically verified as determined by the engineer by comparing the computed hammer stroke with the observed stroke on rams that have rings on the ram or by placing a temporary scale extending above the ram cylinder.

(3) Closed-End Diesel Hammers: Closed-end diesel hammers used to drive precast concrete piles shall be capable of providing a selection of at least three fuel settings that will produce varying stroke lengths.

Closed-end (double acting) diesel hammers shall be equipped with a bounce chamber pressure gauge mounted to be easily accessible by the engineer. The contractor shall provide the engineer a chart, calibrated to actual hammer performance, equating bounce chamber pressure to either equivalent energy or stroke for the closed-end diesel hammer to be used. The calibration between bounce chamber pressure and actual hammer performance should be performed within 30 calendar days prior to starting driving and at 90 calendar day intervals thereafter.

(4) Hydraulic Impact Hammers: The power plant and equipment furnished for hydraulic hammers shall have sufficient capacity to maintain the hammer at the volume and pressure specified by the manufacturer. The power plant and equipment shall be equipped with accurate pressure gauges that are easily accessible to the engineer. These hammers shall be equipped with sensors or other approved devices capable of monitoring and displaying hammer performance.

(5) Gravity Hammers: Gravity hammers, if permitted in the contract, shall only be used to drive timber piles. When gravity hammers are permitted, the ram shall weigh between 2,000 and 3,300 pounds (between 900 and 1500 kg) and the height of drop shall not exceed 10 feet (3 m). In no case shall the weight of gravity hammers be less than the combined weight of helmet and pile. All gravity hammers shall be equipped with hammer guides to ensure concentric impact on the helmet.

(b) Drive System Components and Accessories:

(1) Hammer Cushion: All impact pile driving equipment designed to be used with a hammer cushion shall be equipped with a suitable thickness of hammer cushion material to prevent damage to the hammer or pile and to ensure uniform driving behavior. Hammer cushions shall be made of durable, manufactured materials, provided in accordance with the hammer manufacturer's guidelines. Wood, wire rope, and asbestos hammer cushions

shall not be used unless permitted by the engineer. A striker plate as recommended by the hammer manufacturer shall be placed on the hammer cushion to ensure uniform compression of the cushion material. The hammer cushion shall be inspected in the presence of the engineer when beginning pile driving at each structure and after every 100 hours of use during pile driving operations. The contractor shall replace the cushion when the hammer cushion begins to deteriorate or when the reduction in thickness exceeds 25 percent of the original thickness.

(2) Helmet: Piles driven with impact hammers require an adequate helmet or drive head to distribute the hammer blow to the pile head. The helmet shall be axially aligned with the hammer and the pile. The helmet shall be guided by the leads and not be free-swinging. The helmet shall fit around the pile head in such a manner as to prevent transfer of torsional forces during driving, while maintaining proper alignment of hammer and pile.

For special types of piles, appropriate helmets, mandrels, or other devices shall be provided in accordance with the manufacturer's recommendations.

(3) Pile Cushion: A pile cushion shall protect the heads of precast concrete piles. The pile cushion shall be made of plywood, hardwood, or a composite plywood and hardwood material. The minimum pile cushion thickness placed on the pile head prior to driving shall not be less than 4 inches (100 mm). The pile cushion dimensions shall match the cross sectional area of the pile top. A new pile cushion shall be provided for each pile driven unless otherwise permitted by the engineer. The pile cushion shall be replaced during pile driving when the cushion begins to deteriorate or burn. Pile bearing capacity shall not be determined using a new pile cushion until after the pile has been driven a minimum of 5 feet (1.5 m) or 100 blows.

When easy driving conditions exist throughout the entire depth of driving, the engineer may allow the pile cushion to be reused on several piles after guidelines for pile cushion replacement are developed from successful field performance. The objective shall be to maintain consistent energy delivery at the end-of-driving for proper determination of the pile bearing capacity without pile damage.

(4) Leads: Piles shall be supported in line and position with leads while being driven. Pile driver leads shall be constructed in a manner that affords freedom of movement of the hammer while maintaining alignment of the hammer and the pile to ensure concentric impact for each blow. Leads may be either fixed, semi-fixed or swinging types. Swinging leads shall be used in combination with a rigid template providing pile support meeting the approval of the engineer. The pile section being driven shall not extend above

804.06

the leads. The leads shall be of sufficient length to make the use of followers unnecessary and shall be so designed as to permit proper alignment of batter piles.

(5) Templates: A rigid template shall be used when swinging leads are used. When driving battered piles with swinging leads, the template shall be two tiered or equipped with cradles to hold the pile at the required batter, and the bottom of the leads shall be attached to the template. Template construction shall allow the pile to pass freely through the template without binding.

804.07 PREPARATION FOR INSTALLATION OF DRIVEN PILES.

(a) Site Preparation:

(1) Excavation: Piles shall not be driven until after the excavation is complete. Any material forced up between the piles shall be removed to the correct elevation before concrete for the foundation is placed.

(2) Abutment (End Bent) Fill: The full height of the embankment at bridge ends shall be constructed in accordance with Subsection 813.03 before driving affected piles. Piles to be driven through compacted embankment greater than 6 feet (2 m) shall be driven through prebored holes limited in depth to the height of the embankment.

(3) Cofferdams: Prior to driving any piles the contractor shall ensure the cofferdam is stable by monitoring the external stability of the ground outside of the cofferdam, wall inclination, and depth of excavation within the cofferdam. All excavation within the cofferdam shall be complete prior to driving piles. The depth of the excavation within the cofferdam shall be inspected for proper depth with a weighted line or other approved method.

(4) Cone Penetrometer Test (CPT) Probings: The Cone Penetrometer Test (CPT) probings may be taken at all test pile and indicator pile locations, and at the CPT locations shown in the plans for production piling. The probings will be taken by the Department.

Tip elevations for test piles, indicator piles, and permanent piles given in the plans are for estimating purposes only. The final location and pile tip elevations for the test piles and indicator piles will be determined by the engineer from CPT probings. The final pile order lengths will be determined from the test pile or indicator pile results and the CPT probings.

The contractor shall make arrangements with the Department to have the CPT probings taken at least 30 calendar days prior to driving test piles or indicator piles. When necessary, the contractor shall provide equipment to

assist in moving the Cone Penetrometer Test truck around the site. The site for the probings shall be level as directed.

The contractor shall provide Type I portland cement (approximately 1/2 bag per probe hole) for use in grouting the CPT probe holes.

Cone Penetrometer Test probing layout, supplying portland cement, and assistance will be at no direct pay.

(b) Piling Preparation:

(1) Transportation of Precast Concrete Piling: Precast concrete piles shall be supported adequately to prevent damage during transport.

(2) Collars: Collars, bands, or other approved devices to protect timber piles against splitting or brooming shall be provided when necessary, or as required by the engineer.

(3) Painting of Piling: When required by the plans or specifications, the foundation piling will be painted. The area of steel piles or the exterior surface of the steel shell of cast-in-place concrete piles, as specified in the plans shall be cleaned and painted from the top of the pile to a point 10 feet (3 m) below the ground or mudline. The paint system shall be a 2-coat coal tar epoxy-polyamide in accordance with Section 811.

(4) Supporting Holes for Piles: When approved, piles may be set in supporting holes, but in no case shall the depth of the holes be more than 10 feet (3 m) for piles up to 50 feet (15 m) long, or more than 20 percent of the designated penetration of the piles for piles over 50 feet (15 m) long. If additional support is required, templates or falsework above ground shall be furnished. After piles are driven, supporting holes shall be backfilled to finished ground or base of footing with granular-type material acceptable to the engineer and saturated with water.

(5) Splicing Piles:

a. Precast Concrete Piles: Precast concrete piles shall be furnished and driven in full lengths, unless otherwise specified in the plans or approved in writing by the engineer. There will be no direct payment for splicing.

b. Steel Piles: Steel piles shall be furnished and driven in full lengths unless splices are authorized. Splices shall be limited to two field splices per pile. Splicing of steel piles shall be made by welding with full penetration welds in accordance with Section 815.

c. Timber Piles: Timber piles shall be furnished and driven full length.

804.06

d. Cast-In-Place Concrete Pile Shells: Cast-in-place concrete pile shells may be field spliced, but sections that, in the opinion of the engineer, are too short shall not be used. Field splices of shell sections shall be made in accordance with the manufacturer's recommendations and to the satisfaction of the engineer. Welding shall comply with Section 815, except that the prequalification test for field welders will not be required unless directed.

(6) Pickup Straps: Pickup straps shall be cutoff and epoxy grouted prior to driving in coastal areas.

804.08 CONSTRUCTION REQUIREMENTS.

(a) Preboring: Preboring by augering, wet-rotary drilling, or other methods used to facilitate pile driving will not be permitted unless specified in the plans or required by the engineer. When the soil investigation or field trials indicate impenetrable material above the minimum pile tip elevation, preboring may be required to facilitate pile driving. The use of spuds to punch through impenetrable soil layers shall not be permitted without approval. The depth of the prebored hole shall be developed so as to minimize the pile skin friction disturbance and still be sufficient to permit pile installation to the required pile tip elevation. Preboring procedures shall be carried out in a manner that will not impair the capacity of the piles already in place or the safety of existing structures. The contractor shall develop the preboring depth limits based on the soil information obtained from soil boring logs or Cone Penetrometer Test probings and submit the limits to the engineer for approval.

The maximum prebored depth shall be 3 feet (1 m) above pile tip elevation, unless otherwise directed. Prebored holes shall have a maximum diameter of 80 to percent of the pile diameter unless written approval to do otherwise is received from the engineer. The prebored hole diameter for tapered piles shall be determined by the engineer. Upon completion of the preboring, any voids around the pile shall be filled with granular-type material acceptable to the engineer and saturated with water. The contractor is responsible for any and all effects due to preboring.

(b) Jetting: Jetting will not be permitted unless allowed in the plans or required by the engineer. Jetting will not be allowed in footings, header banks, or where stability of embankments or other structures would be endangered unless approved in writing by the engineer. When the soil investigation or field trials indicate impenetrable material above the minimum pile tip elevation, jetting may be required to facilitate pile driving. The jet pipe penetration limit shall be developed to minimize the pile skin friction

disturbance and still be sufficient to permit pile installation to the required pile tip elevation. The contractor shall develop the jet pipe penetration limits based on soil information obtained from soil boring logs or Cone Penetrometer Test probings and shall submit the limits to the engineer for approval. The maximum jet penetration limit shall be 5 feet (1.5 m) above the required pile tip elevation. Extending the maximum jet penetration limit will require written approval by the engineer.

When water jets are permitted, the jetting procedures shall be carried out in a manner which will not impair the capacity of the piles already in place or the safety of existing structures or create a crater around the pile causing it to drift. The contractor shall be responsible for all damage to the site caused by unapproved or improper jetting operations. The number and size of jets and the volume and pressure of water at jet nozzles shall be sufficient to erode material adjacent to the pile but not disturb the soil bearing material within 5 feet (1.5 m) of the required pile tip penetration. The jetting plant shall have sufficient capacity to deliver at all times a pressure equivalent to at least 100 psi (700 kPa) at two 0.75 inches (19 mm) jet nozzles. One jet pipe will be allowed only when the contractor is pre-jetting a hole prior to placing and driving the pile or when driving is interrupted and the jet is placed inside a steel pipe pile or a voided concrete pile. A minimum of two jets will be required when piles are jetted and driven concurrently using external jets. When jetting and driving is required, the jets shall be above the advancing pile tip approximately 3 feet (1 m), or as approved by the engineer. Jetting operations shall cease when the jet penetration limit is reached, and the pile shall then be driven with the approved impact hammer to the final pile tip penetration. The pile bearing capacity shall be determined only from the results of driving after the jets have been withdrawn. The contractor shall control, treat if necessary, and dispose of all jet water in a manner satisfactory to the engineer. Upon completion of jetting a pile, any voids around the pile shall be filled with granular-type material acceptable to the engineer and saturated with water.

(c) Followers and Underwater Hammers: Followers or underwater hammers shall only be used when approved in writing by the engineer. When a follower or underwater hammer is permitted, the first pile in each pile group and every tenth pile driven thereafter shall be sufficiently long to permit being driven without a follower or underwater hammer, to verify that adequate pile capacity is being attained to develop the desired end-of-driving pile capacity for the pile group. The determination of the pile bearing capacity shall be

804.06

made in accordance with Subsection 804.10 using the driving results of the extended piles. No direct payment will be made for cut-off of these extended piles. The follower or underwater hammer and pile shall be held and maintained in equal and proper alignment during driving.

The follower shall be of such material and dimensions to permit the piles to be driven to the length determined necessary from the driving of the extended piles. The follower shall be provided with a socket or hood carefully fitted to the pile head to minimize energy losses and prevent pile damage.

(d) Cast-In-Place Concrete Pile Construction: After shells are driven to the required pile tip elevation and any required reinforcing steel is placed, shells shall be filled with concrete subsequent to their inspection and approval. The contractor shall provide suitable light for inspection of each shell after it has been driven to the required penetration. The shell shall be cleaned of debris and pumped dry before placing concrete. Reinforcing steel shall be securely fastened together to form a rigid cage. Care shall be taken to hold reinforcement in position during filling of piles. Concrete blocks or suitable devices may be used to prevent displacement of the reinforcement cage. Piles shall be filled with concrete to the cut-off elevation. Concrete in the shell shall be vibrated from the lower end of the reinforcing cage to the top of pile. When reinforcing steel is not required, concrete in the top 10 feet (3 m) of the shell shall be vibrated. Driving of additional piles within a radius of 10 feet (3 m) of the completed pile will not be permitted until concrete has been allowed to set for at least 36 hours.

(e) Location and Alignment Tolerance: Piles shall be driven at locations shown on the plans or as ordered in writing. In pile bents, the centroid of a pile at cut-off elevation shall not vary from plan location by more than 3 inches (75 mm) measured perpendicular to the bent, nor more than 6 inches (150 mm) measured along the centerline of the bent. For footing piles, the centroid of load of any pile at cut-off elevation shall be within a 6 inches (150 mm) radius of a circle having the plan location as its center. No pile shall be nearer than 3 inches (75 mm) from any edge of the cap. Any increases in size of cap to meet these edge distance requirements shall be at the contractor's expense. The final pile head at cut-off elevation shall be plus or minus 2 inches (50 mm) of the final grade shown in the plans. Piles shall be installed so that the axial alignment is within 2 percent of the specified alignment shown in the plans. For piles that cannot be inspected internally after installation, an alignment check shall be made before installing the last 5 feet (1.5 m) of pile, or after installation is completed provided the exposed portion of the pile is not less than 5 feet (1.5 m) in length. The engineer may

require that driving be stopped in order to check the pile alignment. Pulling laterally on piles to correct misalignment, or splicing a properly aligned section on a misaligned section shall not be permitted.

If the location and/or alignment tolerances specified herein are exceeded, the contractor shall provide the engineer with a sketch showing the actual versus theoretical positions of the piles. If corrective measures are necessary, the contractor shall bear all costs, including delays, associated with the corrective action.

(f) Installation Sequence: The contractor's approved pile driving sequence to drive individual piles in a footing shall be used unless otherwise directed by the engineer. The pile driving sequence for individual piles in a footing shall be in accordance with one of the following options:

- (1) From the center of the pile group outward.
- (2) By rows from the center of the pile group to the side.
- (3) By rows from one side of the pile group to the other side.

(g) Pile Driving Stresses: The piles shall be driven in a manner as not to exceed the maximum allowable driving stresses.

For steel piles, the maximum compressive driving stresses shall not exceed 90 percent of the yield point of the pile material. For timber piles, the compressive driving stress shall not exceed 3600 psi (25 MPa). For precast prestressed concrete piles, the tensile and compressive driving stress in units of psi (MPa) from Table 804-2 shall not be exceeded.

**Table 804-2
Maximum Allowable Driving Stresses**

Tensile Driving Stress (Normal Environments):	
U.S. Units	Metric Units
$3 \sqrt{f'_c + f_{pe}}$	$0.25 \sqrt{f'_c + f_{pe}}$
Tensile Driving Stress (Corrosive Environments):	
U.S. Units	Metric Units
f_{pe}	f_{pe}
Compressive Driving Stress (All Environments):	
U.S. Units	Metric Units
$0.85 f'_c - f_{pe}$	$0.85 f'_c - f_{pe}$
f'_c = Concrete Compressive Strength, psi (MPa)	
f_{pe} = Effective Prestress, psi (MPa)	

The plans shall indicate if the allowable tensile driving stress of precast-prestressed concrete piles shall be computed for corrosive environments. Pile driving criteria may be provided by the Geotechnical Engineer to maintain pile driving stresses within the maximum allowable driving stresses.

804.06

(h)Extent of Driving: Driving shall be continued until the engineer determines satisfactory penetration and pile bearing capacity have been obtained. Approval from the engineer shall be required to terminate pile driving above the plan tip elevation or order list pile tip elevation. Piles shall be driven to the plan tip elevation or the order list pile tip elevation in accordance with these specifications, unless a minimum pile tip is specified in the plans. If the pile penetration requirements and pile bearing capacity are achieved within 5 feet (1.5 m) of the plan pile tip elevation or order list pile tip elevation, the engineer may consider the penetration and capacity requirements to be satisfied. The following requirements shall be used to evaluate satisfactory pile penetration and pile bearing capacity.

(1) Pile Driving Penetration Requirements: If refusal is encountered above the required plan pile tip elevation or order list pile tip elevation, the contractor may be required to obtain a larger hammer capable of achieving the required penetration, or to use pile installation techniques to facilitate pile driving such as preboring or jetting. Refusal conditions shall require that the approved hammer is operating at the maximum stroke or fuel setting required to achieve the hammer manufacturer's maximum rated energy.

The hammer shall be in proper working order. If the hammer performance needs to be evaluated, the engineer may require dynamic monitoring of the pile driving operations. If the hammer performance indicates that the pile driving system's effective efficiency is not satisfactory, the contractor shall be required to adjust the pile driving system until satisfactory performance is observed. The cost of dynamic monitoring and/or delays due to unsatisfactory hammer performance shall be at the contractor's expense. Dynamic monitoring of hammers performing satisfactorily shall be paid for under the Item 804-17, Dynamic Monitoring.

(2) Pile Bearing Capacity Requirements: The pile bearing capacity shall be determined in accordance with Subsection 804.10.

If pile bearing capacity is less than the required end-of-driving pile capacity at cut-off elevation, the engineer has the option of either loading a permanent pile to determine its ultimate pile capacity, continuing to drive the pile until satisfactory resistance is obtained, or perform a pile restrike to check for increase in pile bearing capacity due to soil set-up. The loading procedure of permanent piles shall be in accordance with Subsection 804.11. The additional length of pile due to the additional driving shall be furnished in accordance with the construction methods in Subsection 804.08(k) for pile extensions. Pile restrikes shall be performed in accordance with Subsection 804.08(i).

If the potential exists for obtaining false pile bearing capacity results due to excess pore water pressure or if this condition was observed during field testing of test piles, indicator piles, or monitor piles, the pile bearing capacity shall be determined from pile restrikes as directed by the engineer.

(i) Pile Restrikes: Pile restrikes are to be conducted as required for test piles, indicator piles, and production piles or as directed by the engineer. Pile restrikes shall be conducted at no direct pay.

The piles to be restruck shall be driven initially to 1 foot (0.25 m) above the required pile tip elevation, or as directed by the engineer. All pile restrikes shall be performed with a warm hammer that has applied a minimum of 20 blows to another pile or dummy block immediately before being used to restrike the selected pile. For precast concrete piles, the original pile cushion used during initial driving shall be used. If the original pile cushion used to drive precast concrete piles is no longer in an acceptable condition, another similar used cushion shall be used. The maximum amount of pile penetration required for each pile restrike shall be 6 inches (150 mm) or a maximum of 50 hammer blows. If the required end-of-driving pile capacity is obtained during the restrike of permanent piles, the pile shall be driven to grade. Restrike blow counts shall be measured as the number of hammer blows per increment of 1 inch (25 mm).

(j) Heaved Piles: Elevations to check on pile heave after driving shall be made at the start of pile driving operations and shall continue until the engineer determines that such checking is no longer required. Elevations shall be taken immediately after the pile has been driven and again after piles within a radius of 15 feet (5 m) have been driven. If pile heave is observed, level readings referenced to a fixed datum shall be taken on all piles immediately after installation and periodically thereafter as adjacent piles are driven to determine the pile heave range. All end bearing piles that have been heaved more than 1/4 inch (6 mm) shall be redriven to the required resistance or penetration at no direct pay. Concrete shall not be placed in pile casings until all piles in a footing have been driven, or as directed by the engineer.

(k) Pile Extensions:

(1) Cast-In-Place Extension of Precast Concrete Piles: When permitted or shown on the plans, a precast pile may be extended a maximum of 5 feet (1.5 m) as shown on the plans. The plans show the length of reinforcing steel to be exposed and the additional size and number of reinforcing bars to be spliced where pile extensions are required. The final cut of the concrete shall be perpendicular to the axis of the pile. Concrete shall be as shown on the plans. Just prior to placing concrete, the top of the pile shall

804.06

be thoroughly wetted and covered with a thin coating of neat cement or other suitable bonding material.

(2) Steel Piles: When permitted or shown on the plans, a steel pile may be extended by splicing in accordance with Section 815.

(I) Pile Cut-Offs:

(1) Precast Concrete Piles: Cut-offs for precast concrete piles shall be made perpendicular to the axis of the pile at the elevation shown on the plans or as directed. Care shall be exercised to minimize spalling of concrete below the cut-off elevation.

(2) Steel Piles: Steel piles shall be cut off perpendicular to the axis of the pile and to the elevation shown on the plans or as directed. Cuts shall be made in clean straight lines and any irregularity due to cutting or burning shall be corrected by grinding or deposits of weld material prior to placing caps.

(3) Timber Piles: The tops of timber piling which support concrete footings or caps shall be sawed off perpendicular to their axes at the required elevation. When piles support timber caps they shall be sawed to a horizontal plane or to the slope specified, in such manner as to fit the cap. Shimming on tops of piles will not be permitted. Treatment of pile heads shall conform to Subsection 812.06.

(4) Cast-in-Place Concrete Piles: After pile shells are fully driven, inspected, and approved, they shall be cut off perpendicular to the axis of the pile at the required elevation.

804.09 UNSATISFACTORY PILES. The procedure used in driving piles shall not subject them to excessive abuse which produces cracking, crushing or spalling of concrete, splitting, splintering and brooming of timber, or deformation of steel. Manipulation of precast concrete piles to force them into proper position will not be permitted. Any pile found to be unacceptable due to internal defects, by improper driving, driven out of proper location, or driven below required elevation shall be corrected at no direct pay by one of the following methods approved by the engineer:

(a) The pile shall be withdrawn and replaced by a new and, if necessary, a longer pile. Additional pile length and/or load testing may be required with no additional compensation due to disturbance of the soil from jetting or other methods used during removal of the pile.

(b) A second pile shall be driven adjacent to the defective pile. This may require driving the replacement pile with a batter in order to place the pile head at the plan location.

(c) The pile shall be spliced or built up as otherwise provided herein or a sufficient portion of the footing extended to embed the pile.

(d) The cap or footing shall be redesigned at no direct pay and shall be approved by the engineer. The contractor will not be allowed additional compensation for increased quantities in a bent or footing due to driving additional piles to correct unsatisfactory piles.

(e) Cracks in concrete piles shall be corrected as follows:

(1) Transverse cracks in piles that show evidence of spalling and or piles with diagonal or longitudinal cracks will be rejected unless the pile has required penetration and resistance and can be cut off below the crack and built up, or it can be repaired by other methods approved by the engineer.

(2) Transverse cracks that show light dusting or powdering during driving shall be repaired by epoxy injection. Driving shall be stopped at the first sign of powdering and the crack shall be injected and cured in accordance with the epoxy manufacturer's recommendations before driving is resumed.

(3) Concrete piles with minor hairline surface cracks will not be cause for rejection or repair provided no change in the crack condition occurs during driving.

804.10 DETERMINATION OF PILE BEARING CAPACITY. The pile bearing capacity is the pile capacity obtained during the end-of-driving or pile restrike. The pile bearing capacity determination shall be made by use of the Dynamic Formula, the Wave Equation, or the Test Pile Loading Results as specified in the plans. If the method of pile capacity is not shown on the plans the Dynamic Formula shall be used.

(a) **Dynamic Formula:** The pile bearing capacity shall be determined by the engineer, based on the dynamic formula. Piles shall be driven with the approved pile driving equipment to the ordered length or other lengths necessary to obtain the required end-of-driving pile capacity. If the end of driving capacity is not shown on the plans the required pile bearing capacity shall be 3.5 times the pile design load.

English Dynamic Formula:

804.10

$$R = \frac{(1.75\sqrt{E_r} \log(10N_b)) - 100}{2}$$

R = Pile Bearing Capacity (Tons)

E_r = Manufacturer's Rated Energy at the field
observed ram stroke (foot – pounds)

N_b = Number of Hammer Blows/Inch

Metric Dynamic Formula:

$$R = (7\sqrt{E_r} \log(10N_b)) - 550$$

R = Pile Bearing Capacity (kiloNewton)

E_r = Manufacturer's Rated Energy at the field
observed ram stroke (Joules)

N_b = Number of Hammer Blows/25 mm

(b)Wave Equation: The pile bearing capacity shall be determined based on a wave equation analysis when required in the plans or directed by the engineer. Piles shall be driven with the approved pile driving equipment to the ordered length or other lengths necessary to obtain the required end-of-driving pile capacity. Approved methods to facilitate pile installation such as preboring, jetting, etc. shall be accounted for in the wave equation analysis.

804.11 FIELD TESTING PILES. When required, the contractor shall drive test piles, indicator piles, or monitor piles of the length, number, size and type specified at the location and penetration shown in the plans or as directed. These piles shall be driven using the approved pile driving system and the

same pile installation method as will be used on permanent piles. Permanent piles may require field testing as directed by the engineer.

(a) Ultimate Pile Capacity: The ultimate pile capacity is the pile capacity that has been determined from either a static or dynamic load test of a test pile, indicator pile, or permanent pile.

(b) Test Piles: Test piles are piles that are driven in advance of the permanent piles for purposes of determining the length of foundation piles by static load testing. Test piles should be long enough to be redriven, if necessary, to the plan tip elevation of the piles at the nearest bent or as directed by the engineer. Test pile length shall be sufficiently long to permit static load testing and dynamic monitoring with the Pile Driving Analyzer. If the test pile is different than the anticipated permanent pile, prior approval must be received from the Chief, Construction Division. All test piles and/or indicator piles shall be inspected by DOTD Fabrication Inspectors prior to delivery to the project.

(c) Indicator Piles: Indicator piles are piles that are driven in advance of the permanent piles for purposes of determining the length of foundation piles by dynamic load testing. The difference between this type of pile and a test pile is that a static load test is not anticipated to be necessary. Indicator piles should be long enough to be redriven, if necessary, to the plan tip elevation of the piles at the nearest bent or as directed by the engineer. Indicator piles will have dynamic monitoring using the Pile Driving Analyzer.

(d) Monitor Piles: Monitor Piles are permanent piles that are monitored during production pile driving for purposes of determining pile driving criteria by dynamic monitoring the pile driving installation. The Pile Driving Analyzer is used to evaluate the pile driving equipment and to monitor the pile driving stresses. This is usually accomplished by monitoring the first permanent pile of its type and size to be driven at each bridge structure or at a specified bent location. The monitor pile is paid for as a permanent pile.

(e) Pile Restrikes: Pile restrikes for test piles, indicator piles, or monitor piles shall be performed in accordance with the time intervals specified below unless otherwise shown in the plans. Test piles that only have static load tests shall have a 1-day restrike after the initial pile installation. Test piles with dynamic monitoring shall have a 1-day restrike after the initial pile installation and a restrike within 24 hours after the load test with the Pile Driving Analyzer monitoring the driving. Indicator piles shall have a 1-day restrike and a 14-day restrike with the Pile Driving Analyzer monitoring the driving.

804.11

(f) Test Site Preparation: When test piles and/or indicator piles are driven to determine the length of foundation piles or when a test pile is being driven on a stream bank where the most critical pile is in the middle of the stream, the test pile and/or indicator pile shall model the subsurface conditions of the permanent piles as directed. The contractor will be required to excavate the test pile location to the elevation of the bottom of the footing or stream and/or scour bottom and to keep this excavation open during driving and loading of test piles. In lieu of the above, the contractor will be permitted to drive the test pile within an approved metal casing. The casing shall extend and be excavated to the most critical elevation; be it the bottom of the footing, stream scour bottom, stream bottom, or elevation specified in the plans. The contractor shall provide any bracing or strengthening of the test pile required during loading or driving operations.

Cast-in-place concrete piles shall be filled with concrete in accordance with Subsection 804.08(d) and the concrete allowed to set for at least 48 hours and have attained a minimum concrete strength of 3400 psi (23.5 MPa) before commencing load testing.

(g) Static Load Test: Test piles will be loaded at least 14 calendar days after initial driving unless otherwise directed by the engineer. All test pile loading results should be reviewed by the engineer to determine the ultimate pile capacity.

(1) Loading Procedure: The load shall be applied in increments of 10 to 15 percent of the design load or as directed. Each load increment shall be held for an interval of 5 minutes. Gross settlement readings, loads, and other data shall be recorded by the engineer before and after the application of each load increment.

Test piles shall be loaded to failure or until 3 times the static load test pile capacity shown in the plans is reached. The test pile will be considered to have failed when continuous jacking is required to maintain the load and the pile is being driven into the ground. Unless otherwise directed, loading shall cease on a plunging pile when the gross settlement has reached 10 percent of the average pile diameter or diagonal dimension or as directed by the engineer. When the plunging load is reached, the loading system shall be allowed to equalize by taking readings at 5 minute increments until three consecutive readings indicate that the equilibrium load has been achieved.

The load shall be removed in decrements of approximately 25 percent of the maximum load placed on the test pile. Gross settlement and load readings shall be recorded 5 minutes after reaching each unloading load decrement. The

final recovery of the unloaded test pile shall be recorded until movement is essentially complete for a period up to 30 minutes.

(2) Load Testing System Approval: The load testing system shall be designed and constructed to allow vertical loads to be applied concentric with the longitudinal axis of the pile to be tested so that the load acting on the pile at any time may be accurately determined and controlled. To ensure concentric loading, a spherical bearing plate will be required to be mounted between the load frame and the pile head. The contractor shall submit for approval the proposed load testing system prepared and sealed by licensed civil engineer in the State of Louisiana. The plans shall include a detailed schematic of the load testing setup including steel bearing plates, load cell and bearing plates when required, hydraulic jack, reaction system, and reference system.

(3) Hydraulic Jack: The contractor shall furnish hydraulic jacks of adequate size to deliver the required load and shall be equipped with a single gauge which shows the total pressure being applied. When 2 or more hydraulic jacks are used, they shall be connected in parallel by a manifold or other device used to direct the flow of fluid to the jacks. The calibrated pressure gauge shall be accurate to within five percent of the true load placed on the test pile. The contractor shall have the entire hydraulic system calibrated for all stages of loading and unloading by an approved independent calibration service. The calibration method shall take into account the travel that the ram in the hydraulic jack will undergo. The certified laboratory report of the calibration tests shall be furnished to the Materials and Testing Section for approval. After the system is calibrated, no replacement parts will be permitted (except the pump) without recalibration of the system.

(4) Displacement Instrumentation: The contractor shall furnish instrumentation to monitor the gross displacement readings at the pile head during load testing. The instrumentation shall consist of two dial or electronic readout gauges capable of measuring displacement to a precision of ± 0.001 inches (± 0.025 mm), with a travel range of 3 inches (75 mm) or as directed. Smooth bearing surfaces perpendicular to the direction of the gauge-stem travel shall be provided for each gauge.

(5) Load Cell: When specified in the plans, the contractor shall furnish the load cell. The load cell and bearing plates shall be of sufficient size and capacity to measure the maximum load being applied. The contractor shall have the load cell recalibrated by an approved testing laboratory if it has not been calibrated within the six months preceding the load test.

804.11

(6) Reaction System: The reaction system shall be designed and constructed to resist the maximum anticipated test load.

a. Load Applied by Hydraulic Jack Acting Against Weighted Box or Platform: A test box or test platform resting on a suitable support shall be constructed over the test pile and loaded with earth, sand, concrete, metal or other suitable material with a total weight greater than the anticipated maximum test load. Supports for the weighted box or platform shall be located as far as practicable from the test pile but in no case less than a clear distance of 5 feet (1.5 m).

b. Load Applied to the Test Pile by Hydraulic Jack Acting Against Anchored Reaction Member: Reaction member anchorages shall be constructed with a minimum clear distance of three times the maximum diameter of the reaction anchorages or test pile (whichever has the greater diameter) but not less than 7 feet (2 m). If permanent piles are used for anchorages, permanent piles shall be resealed after completion of test pile load test. Precast concrete piles shall not be used as anchorages. A member or members of sufficient strength to act as a rigid reaction beam shall be attached to the upper ends of the anchorages. Chains or cables shall not be used to transfer the reaction load to the anchorages.

c. Combination Devices: Load applied to the test pile by hydraulic jacks acting against a combination of devices (a) and (b) as described above.

d. Other Systems: Other systems may be proposed by the contractor for approval by the engineer.

(7) Reference System: The contractor shall provide an independently supported reference beam. The reference beam shall consist of installing two wooden beams on each side of the test pile and braced internally to form a rigid frame. The frame will be supported at each end with sturdy timber stakes a minimum clear distance from the center of the test pile of three pile diameters or 8 feet (2.5 m) (whichever is longer). The reference beam supports shall be located as far as practical from reaction beam supports or anchorages. The reference beam supports shall be driven sufficiently deep to ensure that surface movement will not affect the lateral stability or vertical reference of the wooden frame.

(8) Shelter: When specified in the plans or directed by the engineer, the contractor shall supply a temporary tent or shelter sufficient to cover the pile, reference beams, and displacement monitoring gauges from direct sunlight and rain during the load test.

(9) Loading Permanent Piles: When the pile bearing capacity of a permanent pile in accordance with Subsection 804.10 is less than the test pile bearing capacity and will not correlate with the test pile data or is less than the required end-of-driving pile capacity shown in the plans, the engineer may direct the contractor to either drive permanent piles to a greater depth, restrike the pile after a specified waiting period, or load a permanent pile at the driven tip elevation. When loading a permanent pile is directed, the loading shall be conducted in accordance with the procedure given in Subsection 804.11(g) amended as follows. Permanent piles shall be loaded to failure or until a load equal to two times the design load plus any additional soil resistance required by the Engineer.

(10) Dynamic Load Test: This work consists of assisting the Department in obtaining dynamic measurements with the Department's Pile Driving Analyzer (PDA) of test piles, indicator piles, monitor piles, and permanent piles during initial pile driving and during pile restrikes. The cost of equipment mobilization or any delays due to dynamic monitoring shall be at no direct pay. When dynamic monitoring is specified, the piles shall be lengthened by a distance of 2.5 times the pile side dimension to allow access to the top of the pile at the end-of-driving. The dynamic monitoring shall be performed for the purpose of obtaining the ultimate pile capacity, pile driving stresses, pile integrity, and pile driving system efficiency.

a. Dynamic Monitoring Scheduling: The contractor shall give notice to the project engineer at least 14 calendar days before the scheduled date of driving piles to be monitored. The contractor shall allow a possible three calendar day delay for any scheduling conflicts of the Department's Pile Driving Analyzer personnel. The contractor shall confirm the driving date 3 working days prior to the scheduled driving date. The pile to be monitored and the contractor's pile driving equipment shall be on-site and at the location to be driven at least 24 hours prior to monitoring. The pile driving equipment shall be tested the day prior to dynamic monitoring to ensure that it is in proper working order. The project engineer will notify the Pavement and Geotechnical Services Section to confirm that the pile and all associated pile driving equipment are on site, have been inspected and assembled, and are ready for driving operations at least 24 hours prior to dynamic monitoring. The contractor shall allow for a possible 7 day delay when rescheduling is required due to contractor delay.

b. Pile Driving Monitoring: The contractor shall furnish equipment, materials, and labor necessary for attaching the dynamic monitoring instrumentation. The contractor shall make the piles available

804.11

prior to pile driving for drilling or tapping holes necessary to attach the instrumentation and take wave speed measurements. The contractor shall provide safe, stable, and OSHA approved access to the pile head for attaching the transducers after the pile is placed in the leads. A platform with a working area of not less than 16 square feet (1.5 sq m) shall be provided by the contractor and shall be equipped so that it may be raised to the top of the pile while the pile is located in the leads. Details of the access system for attaching instrumentation for dynamic monitoring shall be included in the pile installation plan. The expected delay for attaching the instruments to the pile will be approximately 1 hour. Occasionally, the pile driving may have to be temporarily interrupted for the transducers to be adjusted or replaced, or the monitoring results assessed. The contractor shall use reasonable care when working with the Pile Driving Analyzer instruments and accessories. The contractor shall be responsible for replacing any damaged equipment caused by the contractor.

During pile driving operations the Department will monitor with the pile driving analyzer the pile driving stresses induced by the contractor's hammer to ensure that the pile is not being damaged. When necessary, the contractor shall reduce the driving energy transmitted to the pile.

(11) Redriving Test Piles: When steel test piles or indicator piles fail to reach the required ultimate pile capacity, and redriving is required, steel bearing piles shall be extended by splicing if necessary, and redriven as directed. Precast concrete or cast-in-place concrete test piles or indicator piles shall not be extended and redriven. If directed, the contractor shall drive a new test pile to the designated depth at an approved location.

(12) Test Pile and Indicator Pile Removal: If test piles or indicator piles are not to be used as permanent piles, they shall be removed to a minimum of 3 feet (1 m) below natural ground or stream bed and disposed of as directed.

804.12 MEASUREMENT.

(a) Pilings: Piling will be measured by the linear foot (lin m) of pile below pile cut-off elevation. Redriving of permanent piles used as load test anchorages in accordance with Subsection 804.11(g)(6)b will not be measured for payment.

(b) Splices: Splices required to obtain order lengths will not be measured for payment.

(c) Pile Extensions: No measurement will be made for extensions necessitated by damage to the pile during driving.

(1) Precast Concrete Piles: Measurement of extensions on precast concrete piles will be made by the linear foot (lin m). The length of cut-back on the ordered length of pile will be added to the net length of extension to obtain the gross length of extension. The gross length of extension will be multiplied by four to determine the quantity for payment. No deduction will be made from the ordered length of pile driven due to cut-back for splicing.

(2) Steel Piles: Steel piles shall be measured to the linear foot (lin m). Measurement of extensions on steel piles will be made by the linear foot (lin m). The total number of linear feet (lin m) of piling driven will be determined by adding 2 feet (0.5 m) to the net length of piling for each authorized splice in place in the finished structure.

(3) Other Piles: Measurement of extensions on other types of piles will be made by the linear foot (lin m) for that portion of the pile added to the original length of pile driven, which includes any additional driving required.

(d) Cut-Offs: Cut-offs made as directed will be measured by the linear foot (lin m). Payment will not be made for cut-off of a pile unless the length of such cut-off is in excess of 1 foot (300 mm), nor will payment for cut-offs be made where they have been necessitated by crushing, brooming, splitting, or other damage resulting from driving. No payment will be made for required cut-offs of cast-in-place concrete pile shells. Such cut-offs will remain the property of the contractor.

(e) Test Piles and Indicator Piles: The number of test piles and indicator piles to be paid for will be the number of piles of each type furnished and driven as directed. Cut-offs of test piles and indicator piles will not be included in any pay length. Test piles or indicator piles pulled and reused as permanent piles will be measured as provided under Heading (a) of this subsection.

(f) Monitor Piles: Monitor piles will be measured under Heading (a) of this subsection. The field testing is paid for under the Dynamic Monitoring, Item 804-17.

(g) Loading Test Piles: The number of test pile load tests to be paid for will be the number of load tests ordered and completed.

(h) Loading Indicator Piles: The number of indicator pile load tests to be paid for will be the number of load tests ordered and completed.

(i) Redriving Test Piles: Redriving of test piles or indicator piles will be measured for each test pile or indicator pile for which redriving is required.

(j) Reloading Test Piles: The number of reload tests performed on test piles or indicator piles to be paid for will be the number of reload tests ordered and completed.

804.11

(k) Loading Permanent Piles: The number of load tests to be paid for will be the number of load tests made as directed.

(l) Dynamic Monitoring: The number of dynamic monitoring to be paid for will be the number of dynamic monitoring occurrences on test piles, indicator piles, monitor piles, and permanent piles ordered and completed. Dynamic monitoring occurrences that are necessary because of contractor error or required in accordance with Subsection 804.06(b)(3) shall not be measured for payment.

(m) Prebored Holes and Jetting: Pilot holes and jetting will not be measured for payment.

804.13 PAYMENT.

(a) Piling: Payment for piling will be made at the contract unit price per linear foot (lin m), which includes all bolting, wrapping or fastening timber fender piles, driving batter piles, concrete and reinforcing steel, jetting or pilot holes, and redriving permanent piles used for anchor piles.

(b)Pile Extensions: Payment for cast-in-place extensions will be made at the contract unit price per linear foot (lin m) for the type and size of pile extended.

(c) Cut-Offs: Payment for cut-offs will be made at the contract unit price per linear foot (lin m).

(d)Test Piles: Payment for test piles will be made at the contract unit price per each. Redriving of test piles will be paid for under Item 804-11.

(e) Indicator Piles: Payment for indicator piles will be made at the contract unit price per each. Redriving of indicator piles will be paid for under Item 804-11. If it is determined from the driving records and the dynamic monitoring that the indicator pile should be load tested, each load test will be paid for under Item 804-09.

(f) Loading Test Piles: Payment for loading test piles will be made at the contract unit price per each.

(g)Redriving Test Piles: Payment for redriving test piles or indicator piles will be made at the contract unit price per each.

(h)Reloading Test Piles: The number of reload tests to be paid for will be the number of reload tests ordered and completed.

(i) Loading Permanent Piles: The number of load tests to be paid for will be the number of load tests made as directed.

(j) Dynamic Monitoring: Payment for dynamic monitoring will be made at the unit price per each.

Payment will be made under:

Item No.	Pay Item	Pay Unit
804-01	Precast Concrete Piles (Size)	Linear Foot (Lin m)
804-02	Treated Timber Piles	Linear Foot (Lin m)
804-03	Steel Piles (Size)	Linear Foot (Lin m)
804-04	Cast-in-Place Concrete Piles (Size)	Linear Foot (Lin m)
804-05	Precast Concrete Test Piles	Each
804-06	Timber Test Piles	Each
804-07	Steel Test Piles	Each
804-08	Cast-in-Place Concrete Test Piles	Each
804-09	Loading Test Piles	Each
804-10	Reloading Test Piles	Each
804-11	Redriving Test Piles	Each
804-12	Loading Permanent Piles	Each
804-13	Precast Concrete Indicator Piles	Each
804-14	Timber Indicator Piles	Each
804-15	Steel Indicator Piles	Each
804-16	Cast-in-Place Concrete Indicator Piles	Each
804-17	Dynamic Monitoring	Each

Section 805 Structural Concrete

805.01 DESCRIPTION. This work consists of furnishing, placing, finishing and curing portland cement concrete in bridges, culverts and other structures.

Quality assurance requirements shall be as specified in the latest edition of the Department's publication entitled "Application of Quality Assurance Specifications for Portland Cement Concrete Pavement and Structures" or "Application of Quality Assurance Specifications for Precast-Prestressed Concrete Plants."

Structural excavation and backfill shall conform to Section 802.

At the time of final acceptance, concrete box culverts constructed or extended by the contractor shall be cleaned of debris and soil to the culvert invert.

805.02 MATERIALS. Materials shall comply with the following Sections or Subsections:

Mortar	702.02
Steel Joints	807
Portland Cement Concrete	901
Joint Fillers	1005.01
Joint Sealants	1005.02-1005.06
Strip Seal Joints	1005.05
Waterstops	1005.07
Flexible Plastic Gasket Material	1006.06(b)
Reinforcing Steel	1009
Epoxy Coated Reinforcing Steel and Repair Material	1009.01(e)
Curing Materials	1011.01
Special Surface Finish for Concrete	1011.03
Metals	1013
Precast Box Culvert Units	1016
Epoxy Resin Systems	1017.02
Prefabricated Masonry Pads	1018.06
Elastomeric Bridge Bearing Pads	1018.14
Form Release Agents	1018.24
Geotextile Fabric	1019

Classes of concrete furnished shall be as follows:

Table 805-1
Classes and Uses of Concrete

Concrete Class	Use
A or A(M)	Concrete exposed to sea water, and all other concrete except as listed herein.
AA or AA(M)	Cast-in-place bridge superstructure
D	Pier footings
F	Dams and flood control structures
P or P(M)	Precast bridge members
P(X)	Precast-prestressed bridge girders
R	Nonreinforced sections
S	Underwater sections

805.03 HANDLING AND PLACING CONCRETE AND PRECAST UNITS.

(a) General: In preparation for placing concrete, all sawdust, chips and other debris shall be removed from the interior of forms. Struts, stays and braces serving to hold forms in correct shape and alignment shall be removed from the forms when concrete placing has reached an elevation rendering their use unnecessary.

Traffic shall not be permitted on bridge decks until concrete has been in place for 14 calendar days or has attained 3,500 psi (24.1 MPa) compressive strength. For concrete containing fly ash or ground granulated blast-furnace slag, the deck shall be closed to all traffic, including vehicles of the contractor, until the test specimens have attained a compressive strength of 3,500 psi (24.1 MPa).

Precast nonprestressed bridge unit shall be held at the plant a minimum of 10 calendar days after casting. After 10 calendar days, the units may be shipped, provided the required 28-day compressive strength has been attained.

Concrete shall be placed to avoid segregation of materials and displacement of reinforcement. The use of long troughs, chutes and pipes for conveying concrete from mixer to forms will be permitted only with written authorization. If these devices cause segregation, impede workability, or produce detrimental effects, their use shall be discontinued.

Open troughs and chutes shall be metal or metal-lined. Where steep slopes are required, chutes shall be equipped with baffles or be in short lengths that reverse the direction of movement of concrete.

805.03

Chutes, troughs and pipes shall be kept free from coatings of hardened concrete by thoroughly flushing with water after each pour. Water for flushing shall not be discharged within the structure.

When placing operations involve dropping concrete more than 5 feet (1.5 m), it shall be deposited through a sheet metal or other approved tremie. After initial set of the concrete, forms and any reinforcing bar projection shall not be disturbed.

Concrete, during and immediately after depositing, shall be thoroughly consolidated. Consolidation shall be done by mechanical vibration subject to the following provisions.

(1) Vibration shall be internal unless authorization for other methods is obtained or as provided herein.

(2) Vibrators shall be of an approved type and design, capable of transmitting vibration to concrete at frequencies of at least 4,500 impulses per minute.

(3) Intensity of vibration shall be such as to visibly affect concrete over a radius of at least 18 inches (500 mm).

(4) The contractor shall provide a sufficient number of vibrators to properly consolidate each concrete batch immediately after it is placed.

(5) Vibrators shall be manipulated so as to thoroughly work concrete around reinforcement and imbedded fixtures and into corners and angles of forms.

Vibration shall be applied at the point of deposit and in the area of freshly deposited concrete. Vibrators shall be inserted and slowly withdrawn vertically from the concrete. Vibration shall be of sufficient duration and intensity to thoroughly compact concrete, but shall not cause segregation. Vibration shall not be continued at any one point to the extent that localized areas of grout are formed.

Application of vibrators shall be at points uniformly spaced and not farther apart than twice the radius over which vibration is visibly effective.

(6) Vibration shall not be applied directly to or through reinforcement to sections or layers of concrete which have hardened to the degree that concrete ceases to be plastic under the vibration. It shall not be used to make concrete flow over distances so great as to cause segregation. Vibrators shall not be used to drag concrete in forms.

(7) Vibration shall be supplemented by such spading as necessary to ensure smooth surfaces and dense concrete along form surfaces and in corners and locations inaccessible to vibrators.

(8) These provisions for vibration shall apply to filler concrete for steel grid floor except that the vibrator shall be applied to the steel.

(9) These provisions for vibration shall also apply to precast concrete except that, if approved, the manufacturer's methods of vibration may be used.

Concrete shall be placed in horizontal layers not more than 15 inches (375 mm) thick unless otherwise permitted. When less than a complete layer is placed in one operation, it shall be terminated at a vertical bulkhead. Each layer shall be placed and consolidated before the preceding batch has taken initial set to prevent damage to green concrete and avoid surfaces of separation between batches. The top surface of concrete adjacent to forms shall be finished to a suitable grade strip.

When concrete placement is temporarily discontinued, the concrete, shall be cleaned of laitance and other objectionable material to a sufficient depth to expose sound concrete after becoming firm enough to retain its form.

Where a featheredge might be produced at a construction joint, as in the sloped top surface of a wingwall, an inset form shall be used to produce a blocked out portion in the preceding layer which shall produce an edge thickness of not less than 6 inches (150 mm) in the succeeding layer. Placement of concrete shall not be discontinued within 18 inches (450 mm) of the top of any face, unless provision has been made for a coping less than 18 inches (450 mm) thick, in which case, the construction joint may be made at the underside of the coping.

Following concrete placement, accumulations of mortar splashed on reinforcement steel and forms shall be removed. Dried mortar chips and dust shall not be mixed in fresh concrete.

(b) Reinforced Concrete Box Culvert: The contractor may furnish structures of either cast-in-place concrete or precast concrete units; however, design and installation procedures for precast units will be subject to approval. For the cast-in-place option, the base slab or footings of a box culvert shall be placed and allowed to set before the remainder of the culvert is constructed.

Before concrete is placed in sidewalls, culvert footings shall be cleaned of shavings, sticks, sawdust and other debris and the surface carefully chipped or roughened in accordance with the method of bonding construction joints specified in Subsection 805.06.

For culverts 4 feet (1.2 m) or less in height, walls and top slab may be constructed monolithically. When this method of construction is used, necessary construction joints shall be vertical and perpendicular to the axis of the culvert.

805.03

In construction of box culverts more than 4 feet (1.2 m) in height, concrete in walls shall be placed and allowed to set in accordance with strength or curing time requirements of Subsection 805.11 before the top slab is placed.

If possible, each wingwall shall be constructed monolithically. Construction joints shall be horizontal and located so that no joint will be visible in the exposed face of the wingwall above the ground line.

Precast units shall be cast and placed as shown on the plans. Joints for sectional precast units shall comply with Subsection 1016.02. Joints shall be wrapped with an approved geotextile fabric for a minimum of 12 inches (300 mm) on each side of the joint. Ends of cloth shall be lapped at least 18 inches (450 mm), with the edges and ends suitably secured.

(c) Girders, Slabs and Columns: Concrete in girders shall be deposited uniformly for the full length of girder and brought up evenly in horizontal layers.

Concrete in girder haunches less than 3 feet (900 mm) high shall be placed at the same time as that in the girder web; the column or abutment tops shall be cut back to form seats for the haunches. Whenever a haunch or fillet has a vertical height of 3 feet (900 mm) or more, the abutment or columns, haunch and girder shall be placed in three stages: up to the lower side of haunch, to the lower side of girder, and to completion. For haunched continuous girders, the girder web (including haunch) shall be placed to the top of web. Where the size of pour is such that it cannot be made in a continuous operation, vertical construction joints shall be located within the area of contraflexure.

Concrete in slab spans shall be placed in one continuous operation for each span.

Concrete columns shall be placed in a continuous operation. Concrete shall be allowed to set at least 24 hours before caps are placed. When friction collars are used to support cap forms, concrete columns shall have been poured at least 7 days or shall have at least 3,000 psi (20.7 MPa) compressive strength before caps are placed. Compressive strength cylinders shall be made in accordance with DOTD TR 226 and tested in accordance with DOTD TR 230.

No concrete shall be placed in the superstructure until column forms have been stripped sufficiently to determine the quality of concrete in the columns. The superstructure loads shall not be allowed on the bents until the concrete has attained at least 3,000 psi (20.7 MPa) compressive strength but not less than 7 curing days. Compressive strength cylinders shall be made in accordance with DOTD TR 226 and tested in accordance with DOTD TR 230.

(d) Minimum Placement Rate for Bridge Decks: The contractor shall provide sufficient supervision, manpower, equipment, tools and materials to assure proper production, placement and finish of concrete for each pour in accordance with minimum placement rates specified in Table 805-2 below. If the contractor fails to meet the minimum placement rate, the engineer may reject the pour; further placement of similar nature and size will not be permitted until corrective measures have been taken to assure that the minimum placement rate can be met.

**Table 805-2
Concrete Placement Rates for Bridge Decks**

Pour Size Cubic Yards (Cu m)	Minimum Placement Rate Cubic Yards (Cu m) Per Hour
0-50 (0-40)	20 (15)
51-75 (41-60)	25 (20)
76-125 (61-100)	30 (25)
Over 125 (Over 100)	40 (30)

Pour rates shown are intended for use on simple spans. For all spans, pours are to be completed in four hours. For continuous precast concrete girder spans, the pour rate is based on the volume of concrete in two adjacent spans divided by four hours.

(e) End-On-Construction: The use of end-on-construction will only be allowed for slab span bridges, either cast-in-place concrete or precast concrete, when the construction cannot be conducted from the ground or it is impractical to work from the water surface. The contractor shall make a written request to the Department for approval to use end-on-construction procedures. The contractor shall submit drawings and calculations with his request showing the construction loads to be placed on the structure. The drawings shall also show details of matting systems, crane size, outline dimensions, lifting loads, and extension distance from the crane. The calculations shall analyze the maximum construction loads, including structure dead loads, being applied to the structure. The drawings and calculations shall be stamped and signed by a professional civil engineer registered in the State of Louisiana.

No end-on-construction activity will be allowed on the structure until approved by the Department. Approval of end-on-construction procedures will not relieve the contractor from responsibility for repairing any damages to

805.03

the structure, at no cost to the Department, caused by his construction activities.

805.04 PUMPING. Pumping equipment shall be so arranged that no vibrations result which might damage freshly placed concrete. Pipes carrying concrete to placing area shall be laid out with a minimum of bends and no unauthorized change in size. Where concrete is conveyed and placed by mechanically applied pressure, suitable equipment of adequate capacity shall be used.

A grout mortar, or concrete without coarse aggregate, shall be pumped through the equipment ahead of the regular concrete to provide lubrication to start pumping operations. This material shall not be used in placement. The lubrication process need not be repeated as long as pumping operations are continuous.

Operation of the pump shall be such as to provide a continuous stream of concrete without air pockets. When pumping is completed, concrete remaining in the pipes, if it is to be used, shall be ejected in such manner that there will be no contamination of concrete or separation of ingredients.

805.05 DEPOSITING CONCRETE UNDERWATER. Concrete shall not be deposited in water except on approval. The method of placing shall be approved by the engineer and conform to the following:

To prevent segregation, concrete shall be placed in its final position by means of a tremie and shall not be disturbed after being deposited. Concrete shall be placed in caissons, cofferdams or watertight forms.

For underwater parts of structures, concrete seals shall be placed in one continuous operation. The surface of the concrete shall be kept as nearly horizontal as possible; still water shall be maintained at the point of deposit.

A tremie shall consist of a tube at least 10 inches (250 mm) in diameter; if constructed in sections, the couplings shall be watertight. Tremies shall be supported so as to permit positioning anywhere over the top surface of the work and for rapid lowering when necessary to retard or stop the flow of concrete.

When concrete is dumped into the hopper, flow may have to be induced by slightly raising the discharge end of the tremie, but always keeping it in deposited concrete. Flow shall be continual until the work is completed. Aluminum tremies will not be permitted.

Dewatering may proceed when the concrete is sufficiently hard, but not for at least 72 hours after concrete placement is completed. Prior to constructing

succeeding portions of the structure, laitance or other unsatisfactory material shall be removed from the surface by scraping, chipping or other means which will not damage the concrete.

805.03

805.06 CONSTRUCTION JOINTS.

(a) General: Construction joints shall be made only where located on the plans or shown on the pouring schedule, unless otherwise approved. When not detailed on the plans, construction joints shall be placed as directed. Raised shear keys or reinforcing steel shall be used where necessary to transmit shear or bond sections together.

(b) Bonding: Forms shall be retightened before placing new concrete on or against hardened concrete.

(1) Neat Cement Slurry Joints: The surface of hardened concrete shall be roughened as required in a manner that will not leave loosened particles of aggregate or damaged concrete at the surface. It shall then be thoroughly cleaned of foreign matter and laitance, and saturated with water. All surfaces shall be thoroughly coated with a neat slurry to ensure that adequate mortar is placed at the juncture of the hardened and newly deposited concrete. New concrete shall be placed before the grout has attained its initial set. Placing of concrete shall be carried continuously from joint to joint. Edges of joints which are exposed to view shall be finished true to line and elevation.

(2) Epoxy Resin Joints: Vertical surfaces of bridge deck construction joints and other construction joints shall be coated prior to each succeeding pour with an approved Type II, Grade B or Grade C epoxy resin applied according to the manufacturer's recommendations. Surfaces of hardened concrete to which new concrete is to be bonded shall be cleaned of foreign material, loose or unsound concrete by sandblasting, hammers or wire brushes. Grease or oil shall be removed with a detergent wash such as trisodium phosphate, and the entire area washed with fresh water and brushed with a stiff brush. If a detergent is not required, dust and small particles not removed by other cleaning methods shall be removed by washing.

(3) Unless a joint type (1) or (2) above is specified in the plans or specifications, the surface of the hardened concrete shall be thoroughly cleaned of foreign matter and laitance, and saturated with water prior to pouring fresh concrete.

805.07 CONCRETE EXPOSED TO SALT WATER. Concrete shall be thoroughly consolidated and stone pockets shall be avoided. No construction joints shall be formed between levels of extreme low water and extreme high water. Salt water shall not come in contact with concrete for at least 30 calendar days.

805.08 FALSEWORK. Detailed plans for falsework shall be furnished in accordance with Section 801.

Falsework shall be designed in accordance with Subsection 801.04.

Falsework which cannot be founded on a satisfactory footing shall be supported on piling spaced, driven and removed in an approved manner. Falsework shall be set to give the finished structure the specified camber.

805.09 FORMS.

(a) Construction: Forms shall be of wood, metal or other approved material, built mortartight and of sufficient rigidity to prevent distortion due to pressure of concrete and other loads incident to construction operations.

Forms shall be constructed and maintained to prevent warping and opening of joints due to shrinkage of lumber. Forms shall be substantial and unyielding and so designed that finished concrete will conform to proper dimensions and contours. Design of forms shall take into account the effect of vibration of concrete as it is placed.

(b) Form Surface: Forms for exposed surfaces shall not adhere to nor discolor concrete. Forms shall be made of either metal or dressed lumber of uniform thickness with or without approved form liner and shall be mortartight. Forms for reentrant angles shall be chamfered and forms shall be filleted at sharp corners. Forms for projections, such as girders or copings, shall be given a bevel or draft to ensure easy removal.

When possible, forms shall be daylighted at intervals not greater than 10 feet (3 m) vertically, the openings being sufficient to permit free access for inspecting, working and spading the concrete.

(c) Form Ties: Metal ties or anchorages within forms shall be constructed to permit their removal to a depth of at least 1/2 inch (13 mm) from the face without damage to concrete. If wire ties are permitted, upon removal of the forms, wire shall be cut back at least 1/4 inch (6 mm) inside from the face of the concrete with chisels or nippers. Fittings for metal ties shall be of such design that, upon their removal, cavities left will be of the smallest possible size. Cavities shall be filled with cement mortar and the surface left sound, smooth, even and uniform in color.

Fiberglass ties may be used and shall be ground flush with the concrete surface.

(d) Setting and Maintaining: Forms shall be set and maintained reasonably true to required line and grade until concrete is sufficiently hardened. When forms are deemed to be unsatisfactory, either before or during placing of concrete, the work shall be stopped until defects have been

corrected. Forms shall be so designed that portions where finishing is required may be removed without disturbing portions of forms to be removed later and, as far as practical, so that form marks will conform to general lines of the structure. For narrow walls and columns, where the bottom of the form is inaccessible, lower form boards shall be left loose so that they may be removed for cleaning out immediately before placing concrete.

(e) Re-Used Forms: Shape, strength, rigidity, mortar-tightness and surface smoothness of re-used forms shall be maintained. Warped or bulged lumber shall be resized before being reused. Unsatisfactory forms shall not be re-used.

(f) Surface Treatment: Forms shall be treated with an approved form release agent prior to placement of reinforcing steel. Release agents which will adhere to or discolor concrete shall not be used.

Prior to placing concrete, the interior of forms shall be cleaned of dirt, sawdust, shavings or other debris. Forms shall be inspected then saturated with water immediately prior to placing concrete.

(g) Steel Stay-in-Place Forms: Steel stay-in-place forms can only be used when approved by the DOTD Chief Construction Engineer. Steel stay-in-place forms shall conform to the requirements of Subsection 1013.25. The dead load deflection of steel stay-in-place forms shall not exceed $L/240$ or 3/8 inch (9 mm). Concrete admixtures or set accelerators containing chlorides will not be allowed in the concrete when placed against steel stay-in-place forms.

When allowed, the use of steel stay-in-place forms will require:

(1) Reinforcing chairs made for use with stay-in-place forms that will span the corrugations and properly support the reinforcing steel.

(2) Metal chairs in contact with the metal forms shall be hot-dipped galvanized, electroplated with zinc (GS Grade), epoxy coated, or made of stainless steel.

(3) Repair of any damage to galvanized surfaces on the metal pans or the visually exposed surfaces of the support angles with a cold galvanizing compound from QPL 23.

(4) Removal of any portion of the support angle leg that sticks up into the bottom of the deck by more than 1/2 inch (13 mm).

(5) Steel girders and stringers to be shielded to prevent weld splatter or arc strikes on them during the installation of the support angles.

(6) Contractor responsible for any additional temporary bracing requirement to prevent rotation of exterior girders.

805.10 CURING. Concrete in substructures for grade separation structures, superstructures of major structures, and railroad underpasses shall be cured with wet burlap or combined wet burlap and white polyethylene sheeting. Precast concrete shall be cured in accordance with Subsection 805.14(e).

A Type 1-D curing compound complying with Subsection 1011.01 may be used for curing concrete in minor drainage structures and bridge substructures and diaphragms when surfaces do not require a Class 2A finish. When membrane curing is used, exposed reinforcing steel and construction joint surfaces shall be covered or shielded to prevent coating with curing compound. Construction joint surfaces shall be wet cured by approved methods as soon as possible after concrete placement. Concrete surfaces in contact with forms shall be sealed immediately after completion of form removal and surface finishing. Membrane curing shall be applied as soon as surface moisture has evaporated. Method and application rate of curing compound shall be in accordance with the manufacturer's recommendations, but in no case shall the application rate be less than one gallon per 100 square feet (one liter per 2.5 sq m) surface area. The compound shall be applied in one or two applications. If the compound is applied in two increments, the second application shall follow the first application within 30 minutes. Satisfactory equipment shall be provided, with means to properly control and direct application of curing compound on concrete surfaces to result in uniform coverage.

If rain falls on newly coated concrete before the film has dried sufficiently to resist damage, or if the film is damaged, a new coat of compound shall be applied to affected portions.

When curing with burlap, the exposed concrete immediately after finishing shall be covered with two thicknesses of wet burlap. Burlap shall be fixed so that it is in contact with the concrete at all times and shall be kept continuously wet for at least 5 curing days after concrete is placed, with curing days as defined in Subsection 805.11.

In bridge deck construction, exposed surface of decks shall be sprayed uniformly with a Type 2 curing compound immediately after final texturing as an interim curing measure in accordance with Subsection 601.10(a). Exposed reinforcing steel and joints shall be covered or shielded to prevent contact with curing compound. Moist curing methods stated herein shall then be used on the deck when concrete has set sufficiently to support burlap without marring the surface.

805.10

805.11 REMOVAL OF FALSEWORK AND FORMS. Except as otherwise specified herein, face form for barrier curbs or rails and side forms for caps requiring a Class 2A finish shall be removed not less than 1/2 nor more than 2 curing days after concrete is placed to permit finishing.

Forms for surfaces not requiring a Class 2A finish, and supporting forms and falsework for structure members such as bent caps, beams and slabs, shall be removed in accordance with one of the following methods. For concrete containing fly ash or ground granulated blast-furnace slag, only Method 1 shall be used.

Method 1: Forms and falsework may be removed as soon as concrete has attained a compressive strength, as determined by cylinder tests, indicated in Table 805-3:

**Table 805-3
Removal of Forms and Falsework**

Concrete Class	Compressive Strength, Psi (MPa)
A	3,000 (20.7)
A(M)	4,000 (27.6)
AA	3,500 (24.1)
AA(M)	4,000 (27.6)
D	2,500 (17.2)
F	3,200 (22.1)
P (nonprestressed)	3,000 (20.7)
P(M) (nonprestressed)	3,600 (24.9)
R	1,600 (11.0)

Test specimens will be made in accordance with DOTD TR 226 from the same concrete and cured under the same conditions as the portion of the structure involved. Specimens will be tested in accordance with DOTD TR 230.

Method 2: Forms and falsework may be removed when concrete has aged for the minimum number of curing days in Table 805-4:

**Table 805-4
Forms and Falsework Removal Schedule**

Forms	Curing Days
Under slabs, beams or pile caps with span lengths less than 10 feet (3.0 m)	7 days
Under slabs, beams or pile caps with span lengths of 10 to 17 feet (3.0 to 5.0 m)	7 days plus 1 day for each foot (300 mm) of span over 10 feet (3 m)
Under slabs, beams or pile caps with span lengths over 17 feet (5.0 m)	14 days
Under portion of slabs that cantilever more than 1 foot (300 mm)	7 days
Walls, columns, side forms for beams, pile caps and slabs that cantilever less than 1 foot (300 mm)	1 day
Caissons	1 day
Precast nonprestressed bridge units (side forms)	1 day

The term "curing day" will be interpreted as a calendar day on which the temperature is above 50°F (10°C) or 55°F (13°C) if ground granulated blast furnace slag is used in concrete for at least 19 hours. Colder days may be counted if approved methods are used to maintain air temperature adjacent to concrete above 50°F (10°C) throughout the day.

During continued cold weather, when artificial heat is not provided, the engineer may permit removal of forms and falsework at the end of a period of calendar days equal to two times the number of curing days stated above.

The foregoing provisions for form and falsework removal shall apply only to forms or parts of forms so constructed as to permit removal without disturbing forms or falsework which are required to be left in place for a longer period on other portions of the structure.

Methods of form removal likely to cause overstressing of concrete shall not be used. Forms and their supports shall not be removed without approval. Supports shall be removed in such manner as to permit concrete to uniformly and gradually take stresses due to its own weight.

805.11

805.12 EXPANSION AND FIXED JOINTS, AND BEARINGS.

(a) Open Joints: Open joints shall be constructed by insertion and subsequent removal of a wood strip, metal plate or other approved material. Insertion and removal of the template shall be accomplished without chipping or breaking corners of concrete. Reinforcement shall not extend across an open joint.

(b) Filled Joints: Joints to be sealed with poured seals shall be formed and constructed similar to open joints. For joints with preformed filler, the filler shall be in correct position when concrete is placed.

(c) Joint Seals: Joints shall be sealed full width, including curbs and sidewalks. The concrete shall be at least seven days old prior to sealing. Liquid poured or silicone sealant may be used, however the same type sealant shall be used for the entire structure.

(1) Liquid Poured: Before application of the sealant, joint faces shall be sandblasted. Joints shall be thoroughly dry at the time of installation. Sealants shall be installed in accordance with the manufacturer's recommendations. The material's shelf life shall not be exceeded. The ambient air temperature at the time of application shall be at 70°F (20°C) or greater. Application shall be done by a machine with a powered mixing device with an accurate method of proportioning and mixing the components.

Primers, when required, shall be applied as directed by the manufacturer; however, it shall be applied the same day as installation and shall be tack free prior to installation of sealants.

Joints shall be backed with an approved backer material. Prior to cleaning the joint faces, the top of the joint filler shall be removed to a depth to allow for placement of the backer material, joint sealant, and sealant recess below the finished surface. The backer material shall be compressed into the joint such that it adheres tightly to the sides of the joint.

(2) Silicone Sealant: The silicone sealant shall comply with Subsections 1005.02(c) or (d). The joint faces shall be sandblasted prior to sealing, and the faces shall be dry and dust free at the time of installation. The silicone sealant shall be installed in accordance with the manufacturer's recommendations, and the air temperature at the time of placement shall be at least 50°F (10°C). The sealant material shall be tooled by approved methods to force the material against the joint walls.

Joints shall be backed with an approved backer material. Prior to cleaning the joint faces, the top of the joint filler shall be removed to a depth to allow for placement of the backer material, joint sealant, and sealant recess below the

805.12

finished surface. The backer material shall be compressed into the joint such that it adheres tightly to the sides of the joint.

(d) Strip Seal Joints: Joints shall be free of loose rust, and thoroughly clean and dry at the time of installation. Joint seal glands shall be installed in accordance with the manufacturer's recommendations.

Stretching of the seal gland shall be minimal. When installation procedures appear to cause stretching, random inspection will be made. Frequency and thoroughness of inspections shall be as directed. Maximum allowable stretch shall be 5 percent. When maximum limits are exceeded, and the adhesive lubricant has chemically set, the seal shall be completely removed and cleaned, the joint recleaned and reinstallation made at no direct pay.

The adhesive lubricant shall be applied just prior to installation of the gland and shall be sufficient to completely cover the contact surfaces of the steel extrusion and the seal glands. Installation shall be done in a manner that least disturbs the adhesive lubricant. Dilution of the adhesive lubricant will not be allowed.

The joint manufacturer shall submit shop drawings in accordance with Subsection 801.03 and shall supervise the installation and provide the necessary technical expertise.

Welding shall be in accordance with Section 815. Shop fabrication and fabrication inspection shall conform to Section 807.

Temporary restraints placed in joints shall be removed as soon as possible after placing concrete adjacent to the joint.

(e) Preformed Polyurethane Expansion Joint Filler: Joint fillers shall be installed as directed.

(f) Steel Joints: Plates, angles or other structural shapes shall be fabricated to conform to the plans and section of the concrete floor. The surface in the finished plane shall be true and free of warping. Positive methods shall be employed in placing joints to keep them in correct position during placing of concrete. The opening at expansion joints shall be designated on the plans at the prescribed temperature. The required clearance shall be accurate considering temperature effects and stage of construction at the time of installation.

Temporary restraints placed in joints shall be removed as soon as possible after placing concrete adjacent to the joint.

(g) Waterstops: Adequate waterstops of metal, rubber or plastic shall be placed as shown on the plans. Where joint movement is to be provided,

805.11

waterstops shall be of a type permitting such movement without damage. They shall be spliced, welded or soldered to form continuous watertight joints.

(h) Bearing Surfaces: Masonry surfaces on which bearings are to be set shall be finished to ensure uniform bearing at required grade and elevation.

(i) Elastomeric Bridge Bearing Pads: Bearings shall be specified by durometer hardness, size and configuration and, in the case of laminated bearings, by thickness of individual layers of elastomer and the size and position of special connection members required to be vulcanized with the bearing.

(j) Expansion Devices: Rockers or other expansion devices shall be accurately set considering temperature effects and stage of construction at the time of installation.

805.13 CONCRETE SURFACE FINISHES. Surface finishes shall be classified in accordance with Table 805-5 below.

**Table 805-5
Concrete Surface Finishes**

Class 1	Ordinary Surface Finish
Class 2A	Special Surface Finish
Class 4	Sandblast Finish
Class 6	Bridge Deck Finish
Class 7	Sidewalk Finish
Class 8	Precast Prestressed Concrete Finish

All concrete shall be given Class 1, Ordinary Surface Finish, in addition to any other type of finish specified.

Bridge deck surfaces shall be given a Class 6, Bridge Deck Finish.

(a) Class 1, Ordinary Surface Finish: Immediately following the removal of forms, fins and irregular projections shall be removed from all surfaces except from those which will not be exposed to view after construction or are not to be waterproofed. Cavities produced by form ties and other holes, honeycombed spots, broken corners or edges and other defects shall be cleaned and, after having been kept saturated with water, shall be pointed and trued with a mortar of cement and fine aggregate mixed in the proportions used in the concrete being finished.

Mortar used in pointing shall be not more than 1 hour old. Water shall be added to a workable consistency. Concrete shall then be cured as specified under Subsection 805.10. Construction and expansion joints shall be free of

mortar and concrete. Joint filler shall be left exposed for its full length with clean and true edges.

Surfaces shall be true and uniform. Surfaces which cannot be satisfactorily repaired shall be coated as specified for Class 2A, Special Surface Finish.

Exposed surfaces not protected by forms shall be struck off with a straightedge and finished with a wood float to a true, even surface. Use of additional mortar to provide a grout finish will not be permitted.

(b) Class 2A, Special Surface Finish: The Class 2A Special Surface Finish will be used as required by the plans and additionally as follows: visually exposed faces of wingwalls, retaining walls, railings and parapets; outside faces of girders, slabs, brackets, curbs, headwalls, parapets, and vertical faces of caps and columns. Wingwalls shall be finished from the top to 1 foot (300 mm) below finish slope line on the exposed face and shall be finished on top for a depth of 1 foot (300 mm) below the top on backfill sides. When the Special Surface Finish is used, it shall be used throughout the structure.

Application of the Special Surface Finish shall not be started until other work which might mar the surface finish is complete and finishing operations can be carried out continuously on a structure.

The same materials and methods shall be used for all surfaces on the project given this Special Surface Finish.

(c) Class 4, Sandblasted Finish: After 28 curing days, the concrete surface shall be sandblasted with hard, sharp sand to produce an even fine grained surface in which mortar has been cut away, leaving aggregate exposed.

(d) Class 6, Bridge Deck Finish:

(1) Striking Off: After concrete is placed and consolidated according to Subsection 805.03, bridge decks or top slabs of structures serving as finished pavements shall be finished either by hand methods or approved mechanical machines. Continuous span units shall be struck off with approved mechanical equipment.

When hand methods are used, bridge decks shall be struck off with a screed parallel to the centerline of roadway, resting on bulkheads or screed strips cut or set to required roadway cross section. This screed shall be constructed to have sufficient strength to retain its shape, and the cutting edge shall be adjusted to conform to roadway profile. Screeds shall be of sufficient length to finish the full length of spans 30 feet (10.0 m) or less in length. These screeds shall be mechanically operated for finishing spans over 30 feet

805.13

(10.0 m) in length but may not be used to strike off spans in excess of 50 feet (15.0 m) without permission.

Spans over 30 feet (10.0 m) in length and continuous spans shall be placed with lengths of pours as shown on the plans. Screed strips or headers shall be accurately set to specified grades, checked and adjusted as necessary prior to final screeding operations. The screed shall be worked back and forth over the surface until proper profile and cross section are obtained.

Mechanical finishing machines shall be approved power driven machines, traveling on rails, equipped with transverse or longitudinal screeds and adjusted to conform to profile or cross section. Consolidation by vibratory action of the finishing machine will not be permitted. Screeds shall have sufficient strength to retain their shape after adjustment. The finishing machine shall go over each area of bridge deck as many times as required to obtain required profile and cross section. A slight excess of concrete shall be kept in front of the cutting edge of the screed. This excess of concrete shall be carried to the edge of the pour or form and shall be wasted.

Excess water, laitance or foreign materials brought to the surface during finishing operations shall not be reworked into the slab, but shall be removed immediately.

Addition of water to the surface of concrete to assist in finishing operations will be kept to an absolute minimum to facilitate finishing. It shall be applied as a fine spray by means of approved equipment.

(2) Straightedging: After striking off, the surface shall be checked by the contractor with an approved 10-foot (3.0 m) metal static straightedge operated parallel to the centerline of the bridge and shall show no deviation in excess of 1/8 inch (3 mm) from the testing edge of the straightedge. Deviations in excess of this requirement shall be corrected before final finishing. The checking operation shall progress by overlapping the straightedge at least 1/2 the length of the preceding pass. Major deviations shall be corrected by the strike-off, with the straightedge being used to correct minor deviations and as a checking device.

(3) Final Texturing: After surface irregularities have been removed and a satisfactorily smooth surface obtained, concrete shall be given a uniformly textured final surface finish by use of a metal tine texturing device.

Tines shall be approximately 0.025 inches by 0.126 inches (0.6 mm by 3.0 mm) steel flat wire, 4 inches to 5 inches (100 mm to 125 mm) in length, and randomly spaced with a minimum spacing of 3/8 inch (10 mm) and a maximum spacing of 1 1/2 inches (40 mm). No more than 50 percent of the spaces shall exceed 1 inch (25 mm). Groves produced in the concrete shall be

3/16 inch (5 mm) in depth, with a minimum depth of 1/8 inch (3 mm). Grooves shall be transverse to the centerline of roadway and shall extend to within 1 foot (300 mm) of the gutterline. A mechanical or manual operation may be used to propel metal tines, provided required texture is obtained.

Depth of final finish will be checked in accordance with DOTD TR 229. Texturing equipment other than that specified herein may be approved provided it produces an equivalent texture.

During final surface texturing operations, areas improperly finished shall be refloated and refinished as required.

(e) Class 7, Sidewalk Finish: After concrete has been placed, it shall be consolidated and the surface struck off by means of a strike board and floated with a wooden or cork float. An edging tool shall be used on edges and at expansion joints. The surface shall not vary more than 1/8 inch (3 mm) under a 10-foot (3.0 m) metal static straightedge. The surface shall have a granular or matte texture.

(f) Class 8, Precast-Prestressed Concrete Finish: Precast-prestressed bridge members shall be given Class 1, Ordinary Surface Finish at the plant as soon as possible after casting and prior to shipment by the manufacturer. The manufacturer of precast members will be required to adopt measures to reduce the number and size of trapped air cavities to a minimum; an excessive number of these cavities will be cause for rejection of the precast member.

After completion of the structure, construction damage shall be repaired so as to restore the Class 1, Ordinary Surface Finish. Exposed surfaces of precast-prestressed concrete piles shall be cleaned to produce a uniform color.

Cleaning shall not be done in a manner to destroy the glazed surface of concrete resulting from the use of metal forms.

During pouring of decks, the contractor shall keep girders, pilings, and columns clean by washing and shall remove any materials that adhere to the surface and mar the girder finish.

805.14 PRESTRESSED CONCRETE.

(a) Supervision and Inspection: The contractor or fabricator shall provide a technician skilled in the prestress system to be used who shall supervise the work and provide assistance to the engineer as required.

Shop drawings as required under Subsection 801.03 shall be approved and in the possession of the plant inspector at least 2 days prior to beginning fabrication. Access to all parts of the plant engaged in fabrication of prestressed concrete bridge members shall be afforded the engineer while

805.13

prestressed members are being fabricated. Areas where inspection is required shall be kept free of debris.

The Department will inspect all prestressed concrete bridge members. The fabrication, construction and dimensional tolerances of prestressed members shall conform to the limits specified in the "Manual for Quality Control for Plants and Production of Precast-Prestressed Concrete Products (MNL-116-Latest Edition)" published by the Prestressed Concrete Institute, unless otherwise specified herein. Required finishing, repairs and curing shall be accomplished immediately after casting and before placing members in permanent storage.

The fabricator shall furnish the engineer an office with at least 140 square feet (13.0 sq m) of floor space to perform necessary work. Additional space deemed necessary by the engineer shall be provided. This office shall contain a desk, chair, file cabinet with lock, telephone, electric lights, power outlets, shelves and tables, in the quantity required by the engineer. This office shall also contain two separate telephone lines, one dedicated to the telephone and the other dedicated to a computer. Fabricator shall be responsible for paying all utility bills. The office shall be provided with adequate heating, ventilation, air conditioning, and convenient sanitary facilities with running water. This office shall be in good condition, located where there is not excessive noise and restricted to the Department's inspectors. Convenient and adequate reserved parking space shall be provided.

The fabricator shall furnish a concrete cylinder breaking machine of minimum 250,000 lb (1100 kN) capacity complying with ASTM C 39 along with all other necessary supplies and equipment. Suitable facilities for use of this machine shall also be furnished. This machine shall be calibrated by an approved laboratory or calibration service at the manufacturer's expense prior to initial use and at one year intervals thereafter. If, during use, the machine appears to be giving erratic results, recalibration will be required.

(b)General Equipment and Stressing Requirements: The fabricator shall provide all equipment necessary for construction and prestressing. Prestressing shall be done with approved equipment. If hydraulic jacks are used, they shall be equipped with accurate reading pressure gages.

In all methods of tensioning, the stress induced in tendons shall be measured both by jacking gages and elongations of reinforcement, and results shall check within specified limits. Means shall be provided for measuring elongation of reinforcement to the nearest 1/32 inch (mm).

Prior to use in fabrication of prestressed members under these specifications, all jacks to be used, with their gages, shall be calibrated by an approved independent calibration service at no direct pay. A certification shall be supplied to the Construction Section. During the work, if a jack or gage

appears to be giving erratic results or if gage pressure and elongations indicate materially differing stresses, recalibration will be required.

There may be a difference in indicated stress between jack pressure and elongation of about 5 percent. In such event, the error shall be so placed that the discrepancy shall be on the side of a slight overstress. In the event of an apparent discrepancy between gage pressure and elongation of as much as 10 percent, the operation shall be carefully checked and the source of error determined before proceeding.

The amount of stress to be given each stressing element shall be as shown on the plans.

Pretensioning of tendons shall be in prescribed stages to allow for stress equalization throughout the tendon.

(c) Concrete: Design of the concrete mix shall be the responsibility of the contractor subject to approval, but such approval shall not relieve the fabricator of responsibility for the product furnished.

Concrete shall be controlled, mixed and handled as specified in this section and Section 901.

Concrete shall not be deposited in forms until the engineer has inspected reinforcement, conduits, anchorages, cleanliness of forms and prestressing tendons and given approval.

Concrete shall be vibrated internally or externally or both, as ordered. Vibrating shall be done in such manner as to avoid displacement of reinforcing, conduits or tendons.

Tops of prestressed beams shall be rough floated. At the time of initial set, the top of beams shall be scrubbed transversely with a coarse wire brush to remove laitance and produce a roughened surface for future bonding.

(d) Forming for Girders: Prestressed members shall be cast in steel forms. Bolted form joints shall be so spaced that no exterior girder shall have more than two bolted joints or seams. Bolted joints or seams shall be sealed to minimize bleeding.

Prior to placement of concrete and reinforcing steel, forms shall be thoroughly cleaned and uniformly coated with an approved form release agent from QPL 29.

805.13

Outside surfaces of forms shall be maintained reasonably clean and free from concrete build-up.

Forms that have become heated shall be cooled by spraying with water immediately prior to placing concrete in each section.

Girder ends shall be coated with an approved protective coating to protect strand ends.

Prestressed members shall be finished in accordance with Subsection 805.13(f).

(e) Curing: To establish adequacy of curing methods and to determine whether concrete has attained the required compressive strength, seven test cylinders will be made and cured under the same condition as the members. Two cylinders will be tested at the end of 28 calendar days. The remaining five cylinders will be tested at any time requested by the contractor. However, no more than two cylinders will be tested in one day. If all five cylinders have been tested and concrete has not attained required strength, the members involved shall be held at the plant until the 28-day cylinders are tested. If each 28-day concrete cylinder has not attained required strength, all members involved will be subject to rejection. Acceptance will be made in accordance with the Department's manual entitled "Application of Quality Assurance Specifications for Precast-Prestressed Concrete Plants." Curing methods other than steam curing shall be in accordance to Subsection 805.10. Hot weather concrete limitations as stipulated in Subsection 901.11(b) shall not be applicable for steam curing; however, precautions such as cooling of forms will be required.

Steam curing shall be done under a suitable enclosure to contain the live steam in order to minimize moisture and heat losses. Initial application of steam shall be from 2 to 4 hours after final placement of concrete to allow initial set of concrete to take place. When retarders are used, the waiting period before application of steam shall be from 4 to 6 hours. Steam shall be at 100 percent relative humidity. Application of steam shall not be directly on concrete. During application of steam, ambient air temperature shall be increased at a rate not to exceed 40°F (5°C) per hour until a uniform temperature not exceeding 160°F (70°C) is reached. Steam curing shall continue at this temperature until concrete reaches release strength. At the contractor's option, the temperature may be decreased to not less than 100°F (40°C) after 6 hours and held at this temperature until the time of detensioning operations, provided no structural defects occur; if structural defects occur, the defective members will be rejected. At this time, steam curing may be discontinued.

Concrete shall remain covered for at least 2 hours after steam curing has ceased, at which time detensioning shall be accomplished. The 2-hour cool-down period may be waived if the fabricator demonstrates that there will be no adverse effect to members. One recording thermometer showing time-temperature relationship shall be furnished for each 200 feet (60 m) of bed.

(f) Transportation and Storage: Precast girders shall be transported in an upright position. Points of support and directions of reactions with respect to the girder shall be approximately the same during transportation and storage as when the girder is in its final position.

Care shall be taken during storage and handling of precast units to prevent damage. Units damaged by improper storing or handling shall be replaced by the contractor at no direct pay.

Members may be handled immediately after detensioning. If stressing is not done in a continuous operation, members shall not be handled before sufficiently stressed to sustain all forces and bending moments due to handling.

Prestressed members shall be held at the plant until concrete has attained the specified 28-day compressive strength.

Prestressed members, except for prestressed piling, may be installed at any time after completion of stressing and grouting, providing concrete has attained the specified minimum 28-day compressive strength.

Prestressed concrete piling shall be held at the plant for fourteen days after casting, provided the specified minimum 28-day compressive strength has been attained.

(g) Pretensioning Method: Prestressing strands shall be accurately held in position and stressed by approved jacks. A record shall be kept of the jacking force and tendon elongation produced. Several units may be cast in a continuous line and stressed at one time. Sufficient space shall be left between ends of members to permit access for cutting strands after concrete has attained required strength. No bond stress shall be transferred to concrete nor shall end anchors be released until concrete has attained specified release strength as shown by cylinders made in accordance with DOTD TR 226 and cured identically with members and tested in accordance with DOTD TR 230.

Strands shall be cut or released in such order that lateral eccentricity of prestress will be a minimum in accordance with approved shop drawings. Sheathing used to debond prestress strands shall be constructed of polyethylene having sufficient rigidity to prevent bonding of the pre-stressing strand and concrete. The sheathing shall be split type sheathing having a

805.14

minimum thickness of 0.03 inch (0.75 mm) and shall be of sufficient width to maintain a 0.75 inch, $\pm 1/16$ inch (20 mm, ± 2 mm) overlap after being placed on the strand. The joints between segments of sheathing shall be taped to prevent leakage of concrete into the sheathing.

Strands to be prestressed in a group shall be brought to a uniform initial tension prior to full pretensioning. This initial tension of 1,000 to 2,000 pounds (450 to 900 kg) shall be measured by a dynamometer or other approved

means so that its amount can be used as a check against elongation computed and measured.

After initial tensioning, the group shall be stressed until required elongation and jacking pressure are attained within the specified limits.

With cables stressed in accordance with plan requirements and the foregoing specifications and with all other reinforcing in place, the concrete shall be cast to required lengths. Strands shall not be spliced within the casting length of a girder.

(h) Post-tensioning Method: The post-tensioning method shall be in accordance with the latest edition of the AASHTO Standard Specifications for Highway Bridges and the AASHTO Guide Specifications for Design and Construction of Segmental Concrete Bridges, 1989.

(i) Grouting of Bonded Steel: Post-tensioning for prestressed members shall be of the bonded type in which the tensioned steel is installed in holes or flexible metal ducts cast in the concrete and bonded to surrounding concrete by filling the tubes or ducts with grout. The grout shall consist of portland cement and water and may contain an admixture when approved. Portland cement shall be Type I, II or III complying with Subsection 1001.01.

Cement used for grouting shall be fresh and shall not contain lumps or other indications of hydration. Water used in grout shall comply with Subsection 1018.01.

Admixtures, when used, shall impart the properties of low water content, good flowability, minimum bleed and expansion if desired. Their formulation shall contain no chemicals in quantities that may have a harmful effect on the prestressing steel or cement. Non-chloride admixtures complying with QPL No. 58, shall be used.

Aluminum powder of the proper fineness and quantity, or other approved gas evolving material, which is well dispersed through the other admixture may be used to obtain 5 to 10 percent unrestrained expansion of grout.

Prestressing reinforcement to be bonded shall be free of dirt, loose rust, grease or other deleterious substances. Before grouting, ducts shall be free of

water, dirt or other foreign substances. Ducts shall be blown out with compressed air until no water comes through the duct. For long members with draped strands, an open tap at the low point of the duct may be necessary. Grout cubes shall be molded and cured with the member and shall attain a compressive strength of at least 3,000 psi (20.7 MPa) prior to transfer of bond stress or end anchor release. Preparation and testing of grout cubes shall be in accordance with ASTM C 109.

(j) Prestressing Reinforcement: Prestressing reinforcement shall be high tensile strength steel wire, high tensile strength seven wire strand or high tensile strength alloy bars.

Ends of pretensioned strands not to be encased in end diaphragms shall be cut off flush with ends of beam and shall be coated with a suitable asphaltic material.

No more than 75 percent of the minimum ultimate tensile strength of the steel may be used when designing girders or piles with low relaxation strands. For this design the final compressive stress in the concrete shall be at least as great as that required for the design using normal stress relieved strands.

Strand for prestressing shall conform to Subsection 1009.05. The manufacturer shall submit to the engineer three copies of Certificates of Analysis of all required tests results and shall provide a typical load elongation curve for each size and grade of strand shipped. A 24-inch (600 mm) gage length shall be used to obtain the curves.

Load elongation curves shall show elongation in inches per inch (mm/mm), and inches per 10 feet (mm per 3 m), from 0 percent to 80 percent of the minimum ultimate tensile strength.

Mixing of low relaxation strands and normal stress relieved strands in girders and piles will not be permitted.

Any strand that has been stretched during stress relieving operations will be considered to be a low relaxation strand, even if it does not fully meet the requirements of low relaxation strands in Subsection 1009.05, and will not be allowed for use as a normal stress relieved strand nor will they be allowed to be used in the same member containing low relaxation strands meeting Subsection 1009.05.

(k) Precast-Prestressed Concrete Deck Forms: When specified, concrete decks for girder type bridges may be constructed as a composite utilizing concrete form panels conforming to the following requirements in lieu of conventional full depth cast-in-place construction.

805.14

(1) Design: If the contractor elects to use a different concrete panel than detailed in the plans, the contractor shall submit, for approval by the Bridge Design Engineer, detailed drawings of the alternate deck system and design computations for the composite slab and concrete panels complying with the latest AASHTO design specifications and requirements detailed herein.

a. Cover for reinforcing steel shall be as detailed on the plans.

b. Reinforcing steel shall be provided in the concrete panel transverse to the prestressing strands. Steel shall be deformed reinforcing steel with a minimum area of 0.22 square inch per foot (466 sq mm/m) of length.

c. Panels shall be fabricated with 3/8-inch (10 mm) diameter strands only, unless otherwise permitted by the Bridge Design Engineer. The minimum panel length parallel to strands shall be 60 inches (1.5 m).

d. Shear reinforcing steel of 0.40 square inch per 10 square feet (288 sq mm/sq m) of panel surface shall be provided. Top surface of the panel shall be left rough. At approximately the time of initial set, all laitance shall be removed with a coarse wire brush or metal tines at least 1/8 inch (3 mm) deep to ensure proper bond with the cast-in-place concrete.

e. Top of panels may be flat or of other geometric configuration. Panels shall be constructed to provide a minimum vertical clearance of 3/8 inch (10 mm) between the panel surface and longitudinal reinforcing steel in the cast-in-place portion of the deck slab.

f. The top reinforcing steel shall be as required on the panel details for all panel configurations.

g. The joint between adjacent panels shall be butted together and shall be sealed with grout, tape or other approved method prior to placing the cast-in-place portion of the slab.

h. Panels shall extend over girders $3 \pm 1/2$ inches (75 \pm 10 mm). Panels shall be supported on girders with strips of fiberboard, mastic or felt material that provides a mortartight, uniform bearing. Bearing material shall have a width of 1/2 to 1 inch (15 to 25 mm) and maximum height of 1 1/2 inches (40 mm). The strips shall be placed in approximate 4-foot (1.2 m) lengths using an approved adhesive. Openings of 1/2 inch (15 mm) shall be left between adjacent strips placed longitudinally and parallel to edge of girder.

i. Panels shall not be supported transversely on diaphragms.

j. Panels used with steel girders longer than 100 feet (30 m) shall be supported with a saddle system resting on the top flange. No welding will be permitted on girder flanges. For short spans with small camber, panels may be placed on girder flanges with prior approval.

k. If panels are used with concrete girders, vertical stirrup reinforcing steel in the girders shall be changed from the plan details for cast-in-place decks to accommodate placement of the panels. The outer 3 inches (75 mm) of the top flange of girders shall be smoothed for seating the panels; the remaining area of the top girder flange shall be left rough.

l. For skewed spans, end panels may be sawed to fit the skew provided the short side of the panel is not less than 1/2 the length of the long side. From a line through the midpoint of the long side and short side of the end panel to the end of the panel, the effects of prestress shall be neglected and No. 4 (No. 13 M) deformed reinforcement shall be provided to carry required loads.

(2) Materials: Materials for use in the panels shall comply with Subsection 805.02 and the following requirements:

a. Concrete shall be Class P or P(M).

b. Prestressing steel shall be Grade 250 or 270 strand (Grade 1725 or 1860).

c. Deformed reinforcing steel shall be Grade 60 (Grade 420).

d. Welded deformed steel wire fabric shall comply with ASTM A 497.

e. Panels with elements less than 3 1/2 inches (90 mm) thick shall require Grade F aggregate. For all other panels, either Grade A or Grade F aggregate may be used.

f. Steel for continuous high (CHC) bar chairs shall comply with ASTM A 108, Grade 1008.

(3) Construction: Forms shall be installed in accordance with approved fabrication and erection plans. To ensure full bond between the precast panel and cast-in-place concrete, this interface shall be free of foreign material during cast-in-place concreting operations. After erection of panels and prior to pouring cast-in-place concrete, laitance or flakes shall be removed from the top surface of panels by water blasting. Water blasting shall be performed by experienced personnel with equipment providing a pressure of 2,500 to 3,000 psig (17 to 20.7 MPa) and a fan nozzle pressure of approximately 1,500 psig (10 MPa). Immediately prior to pouring cast-in-place concrete, panels shall be saturated with water.

805.14

Riser elevations may have to be adjusted to accommodate the actual camber and vertical curvature while maintaining the minimum cast-in-place slab depth at midspan. Controls for lines and grades above bent caps will be the responsibility of the contractor.

Panels shall be so placed as to obtain the minimum slab thickness shown in the plans within a tolerance of +3/8 inch (10 mm). The tolerance on the cast-in-place concrete cover for the top reinforcing steel will be +1/4 inch to -1/8 inch (+6 mm to 3 mm).

(4) Panel Tolerances: Tolerances for concrete form panels shall be in accordance with Table 805-6.

**Table 805-6
Concrete Form Panel Tolerances**

	Inches	Millimeters
Panel Depth (Thickness)	+1/4, 1/8	+6, 3
Panel Length (Parallel to strands)	±1	±25
Panel Width	+1/8, 1/2	+3, 13
Position of Strands (Vertical)	±1/8	±3
Position of Strands (Horizontal)	±1/2	±13

(5) Payment: Payment will be based on the plan quantities for full depth cast-in-place concrete construction, regardless of the deck construction method used.

805.15 PLACING ANCHOR BOLTS. Anchor bolts in piers, bents, abutments or pedestals shall be set in an approved non shrink grout listed in QPL 47 at the location and in the manner described herein.

Locations of anchor bolts to be built into the concrete shall be verified by the contractor prior to setting. Care shall be taken to ensure proper setting of bolts. Inaccuracies detrimental to the structure shall be corrected by approved means.

Anchor bolts not to be built into the concrete shall be set in preformed holes having a minimum diameter of 3 inches (75 mm) to allow for adjustment and deep enough to admit the anchor bolt. Holes may be formed by inserting oiled wooden plugs, metal sleeves or other approved devices into fresh concrete which are withdrawn after concrete has partially set. Such holes shall be adequately protected from ice formation while open. When erecting the members, the contractor shall set members and shoes in place,

then fill preformed holes sufficiently with grout so that when anchor bolts are placed to required depth, grout will completely fill holes.

If the contractor elects to set anchor bolts either at initial casting or by drilling, he shall verify the centerline-to-centerline spacing between anchor bolt holes of each member before setting the anchor bolts. If bolt holes are drilled, the diameter of drilled holes shall not be less than 1/2 inch (13 mm) larger than the bolt diameter.

Anchor bolts for cantilevered overhead signs and high mast light poles shall be constructed to ensure the proper performance of the double-nut anchor bolt system (baseplate sandwiched between top and bottom nuts). This requires that the bolts be set properly at initial casting, the system be constructed free of damage, and a preload be built into each anchor bolt by a specified tightening procedure. The following guidelines shall be followed:

(a) Inspection: The anchor bolts will be visually inspected for plan compliance (size and grade, bolt galvanizing, projection length, bolt pattern and orientation, etc.). The individual holes in the top template locations shall not be more than 1/8 inch (3 mm) misaligned from their corresponding baseplate holes. Individual bolts must not be out of plumb more than 1/8 inch per 3 feet (3 mm/m). Straightening of misaligned bolts by bending is strictly prohibited. The project engineer must approve any corrective action for misaligned bolts. Bolt and nut threads shall not be used in a damaged condition; anything more than minimal effort by one worker using only a spud wrench to turn off and then back on the nuts shall be brought to the engineer's attention and corrected to his satisfaction.

(b) Lubrication: After inspection of the anchor bolts is completed, their threads shall be cleaned of all foreign matter and then lubricated with beeswax. If erection is delayed more than 24 hours after being lubricated, this cleaning and lubricating must be repeated.

(c) Bolt Tightening Sequence: The pole shall be erected and bolts completely tightened with all cantilever elements removed. The bolts shall be tightened in the sequence specified at each step, which calls for tightening. For an eight-bolt pattern, the bolts shall be numbered 1 through 8 in a clockwise order viewed from above, beginning with bolt 1 on the side away from the heaviest cantilever element. The tightening sequence shall be 1,5,2,6,8,4,7,3. For a six-bolt pattern, the bolts shall be numbered 1 through 6 in a clockwise order viewed from above, beginning with bolt 1 on the side away from the heaviest cantilever element. The tightening sequence shall be 1,4,2,5,6,3.

805.14

(d) Tightening Procedures: The bottom nuts shall be installed on the anchor bolts, one on each bolt. The top template shall be leveled by adjusting the bottom nuts so the template rests on each nut and the distance between the top of the concrete shaft and the bottom face of the nut is approximately 1/2 inch (13 mm). Remove the template, lubricate the bearing surfaces of the bottom nuts and washers with beeswax, and erect and plumb the structure as to the satisfaction of the engineer. Adjust the bottom nuts so that each is bearing equally on its washer against the baseplate. With all cantilever elements removed and with the plumbed structure supported by crane, lubricate the bearing surfaces of the top nuts and washers and install the washers and top nuts and turn them onto the bolts so that each top nut is hand-tight against the washer. Using a wrench, turn the bottom nuts up in the specified sequence to a snug tight condition [snug tight is defined to be the condition where the nut is in firm contact with the baseplate, and it may be assumed that the full effort of a workman on a 12 inch (300 mm) wrench results in a snug condition].

Verify that the structure is still plumb and still supported by the crane. In the specified sequence, turn the top nuts down to the same snug tight condition.

(e) Preload is induced into the bolt by tightening the nuts and measuring the tightness by turn-of-nut method. Tighten each top nut in the specified sequence 30 degrees past snug tight (one-half of a hex nut "flat"). Repeat this process of tightening each top nut an additional 30 degrees down until each top nut has been tightened 60 degrees past snug tight.

805.16 SETTING BENCH MARKS. A bench mark bolt furnished and delivered by the contractor shall be set by the contractor without extra compensation on each bridge. The bench mark bolt shall be either hex head or square head 4 inch by 5/8 inch (100 mm by 15 mm) threaded galvanized bolt. It shall be located on the downstream side of the beginning of the bridge. The bolt shall be placed in the roadway surface near the expansion joint and 4 inch (100 mm) from the barrier rail. For bridges with sidewalks, the bolt will be set in the sidewalk 4 inch (100 mm) from the top of the curb. No permanent plates or markers other than those furnished or specified will be permitted on any structure.

805.17 MEASUREMENT.

(a) General: Quantities of structural concrete, precast prestressed girders and expansion joint seal for payment will be the design quantities as

specified on the plans and adjustments thereto. The design quantities will be adjusted if the engineer makes changes to adjust to field conditions, if plan errors are proven, or if design changes are made.

(b) Structural Concrete: Design volumes of structural concrete are computed from neat dimensions shown on the plans with the following modifications. Deductions are made for the volumes occupied by fillets, scorings and chamfers with cross sectional areas over 1 1/2 square inches (920 sq mm), expansion joints, and embedded structural steel, piling and cylindrical voids of voided slabs. Volumes deducted for embedded piling are based on 12 inches (300 mm) butt diameter timber piling and nominal butt dimensions for other types of piling. No deductions are made for volumes occupied by fillets, scorings and chamfers with cross sectional areas not over 1 1/2 square inches (920 sq mm), reinforcing steel, water piping, electrical conduit, weep holes, drain piping and armored joints.

(c) Precast-Prestressed Concrete Girders: Design quantities of precast-prestressed concrete girders are based on out-to-out lengths shown on the plans.

(d) Expansion Joint Seal and Strip Seal Joint: Design quantities of expansion joint seal and strip seal joint are based on lengths shown on the plans.

(e) Bridge Superstructure and Substructure: Bridge superstructure and substructure will be measured per span.

(f) Reinforced Concrete Box Culverts: Reinforced concrete box culverts of each size and type shall be measured by the linear foot (lin m) in place. The measurement shall be the flow line length, along the centerline, inside face of the headwalls. For multiple barrel structures, the measured length will be the sum of the lengths of all barrels measured as described above.

805.18 PAYMENT.

(a) Structural Concrete: Payment for structural concrete will be made at the contract unit price per cubic yard (cu m), adjusted in accordance with the following provisions.

Class A, A(M), AA, AA(M), D and S concrete will be accepted on a lot basis. A lot will be considered an identifiable pour not exceeding 200 cubic yards (150 cu m) of concrete. A pour of 200 to 400 cubic yards (150 to 300 cu m) will be divided into two lots as equal in size as possible while maintaining identifiability. A pour exceeding 400 cubic yards (300 cu m) will be represented by three lots.

805.14

Two random batches will be sampled for each lot, and three cylinders molded from each batch. The six cylinders per lot will be tested for compressive strength in 28 to 31 calendar days.

In the event of sudden cessation of operation, a minimum of three cylinders will constitute a lot.

Acceptance and payment for each lot will be made in accordance with Table 901-5.

Concrete that is classified as minor structure concrete will be accepted under these specifications and in accordance with Table 901-6.

Formwork, falsework, cofferdams, bracing, pumping, expansion joint fillers, steel punchings in counterweight concrete, excavation and backfill will not be measured for payment.

(b) Precast-Prestressed Girders: Payment for precast-prestressed girders will be made at the contract unit price per linear foot (lin m), which includes all reinforcing steel, masonry, anchor plates, plain or laminated elastomeric bearings, metal or other bearing plates and assemblies or other appurtenances indicated or necessary in the fabrication, handling and erection of the girders.

Tie-rods, nuts and washers will be considered as miscellaneous steel and paid for as provided in Section 807.

(c) Expansion Joint Seal and Strip Seal Joint: Payment for expansion joint seal and strip seal joint will be made at the contract unit price per linear foot (lin m).

(d) Bridge Superstructure and Substructure: Payment for bridge superstructure and substructure will be made at the contract unit price per span, which includes the entire superstructure (with railings) and that portion of the substructure above the bottom of caps.

Acceptance and payment for bridge superstructure and substructure will be made on a lot basis at the contract unit price per span, adjusted in accordance with the following provisions. A lot will be considered an identifiable pour as described in Heading (a) of this subsection. Acceptance and payment for each cast-in-place bridge superstructure and substructure lot will be in accordance with Table 901-5 and Note 1 therein.

(e) Reinforced Concrete Box Culverts: Payment for reinforced concrete box culverts will be made at the contract unit price per linear foot (lin m), which includes connections to existing structures, concrete, reinforcing steel, excavation, backfill, and all other items of material, labor, and equipment necessary to complete the work in accordance with the plans and specifications.

Acceptance and payment for reinforced concrete box culverts will be made on a lot basis at the contract unit price per linear foot (linear meter), adjusted in accordance with the following provisions. A lot will be considered an identifiable pour as described in Heading (a) of this subsection. Acceptance and payment for each cast-in-place reinforced concrete box culvert lot will be in accordance with Table 901-5 and Note 1 therein. Acceptance for each precast reinforced concrete box culvert will be in accordance with ASTM C 1433 (C 1433M).

Payment will be made under:

Item No.	Pay Item	Pay Unit
805-01	Class A Concrete	Cubic Yard (Cu m)
805-02	Class A(M) Concrete	Cubic Yard (Cu m)
805-03	Class AA Concrete	Cubic Yard (Cu m)
805-04	Class AA(M) Concrete	Cubic Yard (Cu m)
805-05	Class D Concrete	Cubic Yard (Cu m)
805-06	Class R Concrete	Cubic Yard (Cu m)
805-07	Class S Concrete	Cubic Yard (Cu m)
805-08	Precast-Prestressed Concrete Girders (Type)	Linear Foot (Lin m)
805-09	Expansion Joint Seal	Linear Foot (Lin m)
805-10	Bridge Superstructure and Substructure	Span
805-11	Strip Seal Joints	Linear Foot (Lin m)
805-12	Reinforced Concrete Box Culverts (Size)	Linear Foot (Lin m)
805-13	Class F Concrete	Cubic Yard (Cu m)

Section 806 Reinforcement

806.01 DESCRIPTION. This work consists of furnishing and placing reinforcing steel for reinforced portland cement concrete structures.

806.02 MATERIALS.

(a) Steel materials shall comply with Section 1009 Grade 60 (Grade 420).

(b) Epoxy coating material and patching material shall comply with Subsection 1009.01. Accessories such as tie wires and metal bar supports used in the fabrication and placement of epoxy coated reinforcing steel shall comply with Subsection 806.06 modified as follows.

(1) **Tie Wires:** Metal tie wires shall be fully coated with an acceptable epoxy, plastic or nylon material.

(2) **Metal Bar Supports:** Metal bar supports shall be coated with an acceptable epoxy or plastic material for a minimum distance of 2 inches (50 mm) from the point of contact with the epoxy coated reinforcing steel.

806.03 STEEL LISTS. Before placing reinforcing steel, two copies of a list of all reinforcing steel showing location, mark number, size and type bend shall be furnished to the engineer. The contractor shall be responsible for the accuracy of the lists and for furnishing and placing reinforcing steel in accordance with the details shown on the plans and as specified.

The contractor shall also furnish the engineer two copies of placing plans for all structures where reinforcing steel is involved, unless the plans contain sufficient detail for proper placement of reinforcing steel. Placing plans shall show the location, type and spacing of supports.

806.04 FABRICATION. Unless otherwise authorized, bent bar reinforcement shall be cold bent to the shapes shown on the plans in accordance with the following requirements:

(a) **Bending:** Stirrups and ties shall be bent around a pin having a diameter of at least four bar diameters for No. 5 (No. 16 M) or smaller bars, and at least five bar diameters for larger bars. All other bars, except as otherwise specified herein, shall be bent around a pin having a diameter as specified in Table 806-1:

**Table 806-1
Pins for Bar Bends**

Bar Size	Minimum Pin Diameter
Nos. 3 through 8 (Nos. 10 M through 25 M)	6 bar diameters
Nos. 9, 10 and 11 (Nos. 29, 32 and 36 M)	8 bar diameters
Nos. 14 and 18 (Nos. 43 M and 57 M)	10 bar diameters

No rebending of bars will be allowed. Special fabrication will be required for bending Nos. 14 and 18 (Nos. 43 M and 57 M) bars more than 90 degrees.

(b)Tolerances: Bars shall be fabricated in accordance with the tolerances specified in Table 806-2. All dimensions given in Table 806-2 are out-to-out of bars.

**Table 806-2
Fabrication Tolerances**

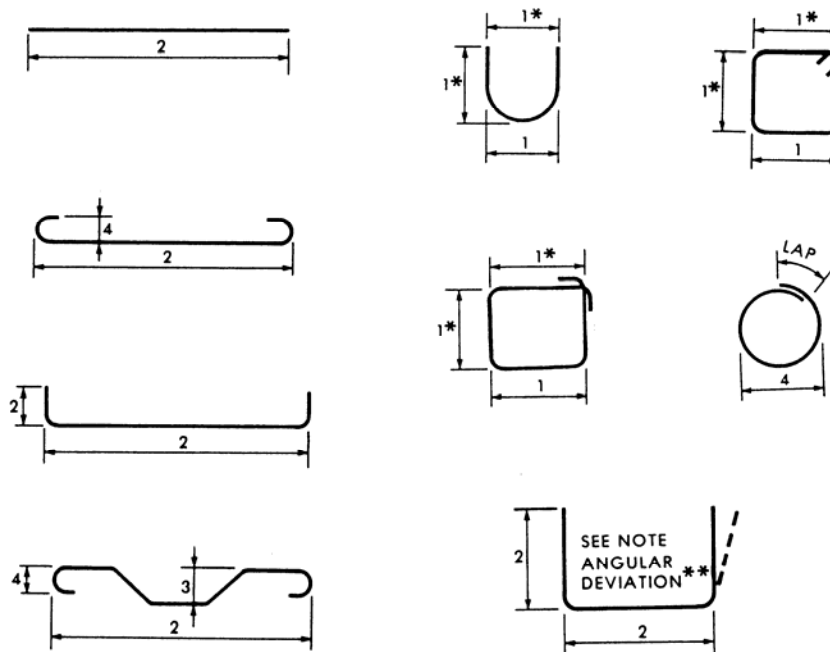

Symbol	Tolerance, Inches (mm)
1	±1/2 (± 13)
2	± 1 (± 25)
3	+0, -1/2 (+0, -13)
4	± 1/2 (±13)

*Not to differ for opposite parallel dimension by more than 1/2 inch (13 mm).
 **Angular Deviation-Maximum ± 2 1/2° or ± 1/2 inch/ft. (40 mm/m), but not less than 1/2 inch (13 mm).

(c) Shipping: Bar reinforcement shall be shipped in standard bundles, tagged and marked in accordance with the Manual of Standard Practice of the Concrete Reinforcement Steel Institute (CRSI). The tags shall be made of durable material and marked in a legible manner with waterproof markings. There shall be at least one tag per bundle attached by wire. The tags shall show size of reinforcing, number of pieces, and mark or length of bars.

(d) Handling and Coating Repairs: Epoxy coated reinforcing steel shall be handled in a manner to avoid damage to the coating. Bundling bands shall be padded. Bundles shall be lifted with multiple supports or strongbacks to prevent abrasion to the coating due to sag.

Patching material used by the applicator and the contractor shall be the same as the prequalified patching material. Repairs shall be made in accordance with the patching material manufacturer's recommendations.

Repairs to the coating will be required on all damaged areas larger than 1/4 inch square (40 sq mm). The total bar surface area covered by patching material shall not exceed 2 percent.

Ends of coated bars cut during field fabrication shall also be coated with the patching material before rusting appears; however, the coated ends are not to be included in the 2 percent maximum coverage of patching material. Hairline cracks without bond loss or other minor damage on fabrication bends need not be repaired.

806.05 PROTECTION OF MATERIAL. Reinforcing steel shall be stored above ground on platforms, skids or other supports and shall be protected from damage.

The various sizes, grades and lengths shall be plainly marked and tagged to facilitate inspection.

Epoxy coated steel bars shall be unloaded and stored on the project site in a manner to avoid damage or contamination. Bars shall be stored off the ground and covered such that formation of condensation and exposure to ultraviolet light is avoided.

806.06 PLACING AND FASTENING. Steel reinforcement shall be placed in the position shown on the plans and firmly held during placing and setting of concrete. When placed in the work, it shall be free from dirt, loose rust, loose scale, paint, oil, grease, form release agent, or other foreign material. Thin powdery rust and light rust need not be removed. Bars shall be tied with No. 14 or 16 gage (2.0 or 1.6 mm diameter) wire at all intersections, except

806.06

where spacing is less than 1 foot (300 mm) in each direction, alternate intersections shall be tied.

Distance of reinforcement from forms shall be maintained by metal chairs, ties, hangers or other approved supports. Precast mortar or concrete blocks may be used when approved by the engineer in applications where concrete is to be cast against soil. Metal chairs in contact with exterior surfaces of concrete shall be hot-dipped galvanized, electroplated with zinc (GS Grade), plastic-coated or stainless steel. Layers of bars shall be separated by approved devices. The use of pebbles, pieces of broken stone or brick, metal pipe and wooden blocks will not be permitted. Vertical stirrups shall pass around main tension members and shall be securely attached thereto. The minimum covering, measured from the surface of concrete to face of reinforcing bars, shall not be less than 2 inches (50 mm) except as follows: bottom of slab, 1 inch (25 mm); stirrups and ties in T-Beams, 1 1/2 inches (40 mm). Additional coverage as shown on the plans shall be provided for reinforcement in bottom of footings or where marine environments, corrosive, abrasive or other severe exposure conditions exist. Reinforcement shall be inspected and will be subject to approval before placing concrete.

During and after installation of epoxy coated bars, the contractor shall repair all significant cuts, nicks and abraded places in the coating on the bars with the epoxy repair material supplied by the epoxy resin manufacturer. Any damaged metallic accessories shall also be repaired with a suitable material. No more than 0.25 percent of the bar surface area may be left bare.

Damaged areas of the reinforcing steel and accessories shall be repaired before rusting occurs. Coated bars when incorporated into the work shall be free from dirt, paint, oil, grease, form release agent, or other foreign substances. Placing of concrete shall be performed in a timely manner with methods and equipment which will not damage the coated materials.

Since the epoxy coating is flammable, the coated bars shall not be exposed to fire or flame. Cutting coated bars by burning will not be permitted. Reinforcing steel to be partially embedded in concrete shall not be field bent unless specified on the plans or permitted by the engineer.

806.07 SPLICING. Reinforcement shall be furnished in the full lengths indicated on the plans. Splicing of bars, except where shown on the plans, will not be permitted without written approval. Splices shall be staggered as far as possible. Unless otherwise specified, bars shall be lapped in accordance with the requirements of Table 806-3. Construction joints shall not be made

806.04

within the limits of lapped bars. In lapped splices, bars shall be placed in contact and wired together in such manner as to maintain the minimum clear distance to other bars and to the surface of concrete. Welding of reinforcement steel shall be done only if detailed on the plans or if authorized in writing. Welding shall comply with Section 815.

When permitted in the plans or specifications, reinforcing steel splices may be made by an approved mechanical butt splicing device listed in QPL 44 and used in accordance with the manufacturer's recommendations. The splice shall develop at least 125 percent of the specified yield strength of the reinforcing steel bars in tension.

Table 806-3
Lap Splice Length for Grade 60 (420) Steel

Bar No.	Lap Splice Length, inches (mm)
3 (10M)	18 (457)
4 (13M)	24 (610)
5 (16M)	30 (762)
6 (19M)	39 (990)
7 (22M)	53 (1346)
8 (25M)	69 (1753)
9 (29M)	88 (2235)
10 (32M)	111 (2819)
11 (36M)	137 (3480)

806.08 SUBSTITUTIONS. Substitutions of different size bars will be permitted with authorization of the engineer. Substituted steel shall have cross-sectional and surface areas equivalent to the design areas or larger.

Reinforcing bars may be substituted for the bars designated in the plans, on a one for one basis, as shown in Table 806-4.

Allowed substitutions will be made at no additional pay.

**Table 806-4
Reinforcing Bar Size Substitutions**

English No.	Metric No.
3	10M
4	13M
5	16M
6	19M
7	22M
8	25M
9	29M
10	32M
11	36M
14	43M
18	57M

806.09 MEASUREMENT. Quantities of reinforcement for payment will be the design weights as specified on the plans and adjustments thereto. Design quantities will be adjusted if the engineer makes changes to adjust to field conditions, if plan errors are proven, or if design changes are necessary.

Design quantities are based on theoretical weights (mass) of nominal size plain round bars as shown in Table 806-5:

**Table 806-5
Reinforcing Bar Weights (Mass)**

Bar No.	Weight (Mass) Lb/Lin Ft (kg/lin m)
3 (10M)	0.376 (0.560)
4 (13M)	0.668 (0.994)
5 (16M)	1.043 (1.552)
6 (19M)	1.502 (2.235)
7 (22M)	2.044 (3.042)
8 (25M)	2.670 (3.973)
9 (29M)	3.400 (5.060)
10 (32M)	4.303 (6.404)
11 (36M)	5.313 (7.907)
14 (43M)	7.650 (11.380)
18 (57M)	13.600 (20.240)

Measurement and payment of structural shapes used as reinforcement will be made in accordance with Subsections 807.53 and 807.54.

The following will not be included in pay quantities:

- (a) Reinforcement furnished for testing purposes.

806.10

(b) Additional reinforcement used for laps in splices other than those shown on the plans.

(c) Additional weight of reinforcement used at the contractor's request as substitutions for reinforcement shown in the plans.

(d) Spacers, clips, chairs and other material used in fastening reinforcement in place.

(e) Additional weight of epoxy coating or cleaning and epoxy coating repair.

806.10 PAYMENT. Payment for reinforcing steel will be made at the contract unit price under:

Item No.	Pay Item	Pay Unit
806-01	Deformed Reinforcing Steel	Pound (kg)
806-02	Deformed Reinforcing Steel (Epoxy Coated)	Pound (kg)

Section 807 Structural Metals

807.01 DESCRIPTION. This work consists of furnishing and placing structural metals for structures.

807.02 MATERIALS. Materials shall comply with Section 1013. When the type of structural steel to be used is not specified, steel complying with AASHTO M 270, Grade 36 (M 270M, Grade 250) shall be used.

807.03 DRAWINGS. Shop drawings and working drawings shall be furnished in accordance with Subsection 801.03.

807.04 MINIMUM SHOP REQUIREMENTS FOR FABRICATION OF STEEL STRUCTURES. The contractor (fabricator) shall provide sufficient lifting capacity, physical plant and equipment for the fabrication of structural steel. The cranes in each working area shall have a combined rated capacity equal to the lifting weight of the heaviest assembly fabricated for shipment unless alternate lifting and turning facilities are approved.

Lifting chains shall be provided with adequate softeners to prevent damage to the corners of material during lifting and turning. When hooks are used for lifting, they shall have sufficient width of jaw and throat to prevent damage to the flanges or to the web-to-flange welds.

Spreader beams, or multiple cranes, shall be provided for lifting plates and long slender members to prevent overstress and distortion from handling.

Shops shall have sufficient enclosed floor spaces to allow oxygen cutting, air carbon arc gouging, assembly and welding to be performed inside, except that shop assembly of field connections for trusses, girders and arches may be performed outside the shop buildings. The fabrication of major steel bridge components (includes all bridge structures other than unspliced rolled beam bridges) shall only be by fabrication shops having a current AISC Certification for Major Steel Bridges. Current AISC Certification for Simple Steel Bridges will be required for fabrication of highway sign structures, secondary members of bridges (such as cross frames), and unspliced rolled beam bridges. Structures that have fracture critical members shall require an AISC Fracture Critical Endorsement to the fabricator's Simple or Major Steel Bridge

Certification. The contractor will be required to provide the engineer with documentation of the certification prior to beginning fabrication.

The engineer may approve limited fabrication and welding outside the shop, provided the fabricator has made provisions to ensure that the quality of the work produced outside the shop buildings will not be adversely affected by weather or other conditions.

All cutting, fitting and welding shall be done in areas that are kept dry. Areas for automatic and semiautomatic welding shall be kept at a temperature not lower than 40°F (5°C) for at least 1 hour before work begins and at all times when work is being performed.

807.05 INSPECTION.

(a) The Department will inspect all structural metal including shop inspection of fabrication and assembly of structural steel, castings and other metal items. A schedule of fabrication for the metal items required for the project, including location of the shop and the dates inspection services will be required, shall be furnished to the Construction Section. This information shall be provided at least 10 days in advance of commencement of layout work on fabricated material.

The engineer will have the authority to reject materials and workmanship which does not conform to the requirements of the contract. The Department's Quality Assurance (QA) inspection of material and workmanship may be conducted before, during and after fabrication. Materials and workmanship which are "in the process" of being fabricated and which are found to contain defects or to have been subjected to damaging fabrication procedures shall be rejected while still in process. The inspector will have the right to perform at the expense of the Department, non-destructive tests of materials and workmanship. Department inspection at the mill and shop is a quality assurance function that may be exercised at the option of the engineer.

It shall be expressly understood that the Department's Quality Assurance will not relieve the contractor of responsibility to perform Quality Control to insure that the products conform to the requirements of the contract and shall not relieve the contractor of responsibility concerning unacceptable materials and workmanship and the responsibility to acceptably repair or replace the same.

The contractor shall furnish means and assistance for testing materials and workmanship. The engineer will have free and safe access at all times to any portion of shops where work is being done under these specifications.

The stamping of any material or finished member shall not preclude its subsequent rejection if found defective. Rejected material shall be promptly replaced.

The contractor or fabricator shall furnish the engineer an office with at least 140 square feet (13.0 sq m) of floor space to perform necessary work. Additional space, as deemed necessary by the engineer, shall be provided. This office shall contain desks, chairs, file cabinet with lock, telephone, electric lights, power outlets, shelves and tables, all in the quantity required by the engineer. The office shall be provided with adequate heating, ventilation and air conditioning and convenient sanitary facilities with running water. This office shall also contain two separate telephone lines, one dedicated to the telephone and the other dedicated to a computer. The contractor or fabricator shall be responsible for paying all utility bills. The office shall be in good repair, located where there is not excessive noise, and restricted to the Department's inspectors only. Convenient and adequate reserved parking space shall be provided.

Metal fabrication work requiring Departmental inspection shall be performed in a plant or shop within the continental United States.

(b)Qualifications: Qualifications of inspectors for Quality Assurance (QA) and Quality Control (QC) will be as specified in the latest edition of ANSI/AASHTO/AWS D1.5 (D1.5M), Section 6.1.3.

(c) Mill Inspection: Mill inspection of structural metals will be as deemed necessary by the engineer; however, five copies of Certificates of Analysis, a notarized Fabricator's Material Statement and a notarized Certificate of Compliance, properly identified as to the intended use, are required and shall be submitted to the Construction Section for approval and distribution.

(d)Obligations of the Contractor: The fabricator's QC Inspectors shall be a separate function of production and shall make the necessary visual inspections prior to assembly, during welding and after welding to insure that materials and workmanship meet the requirements of the contract. The contractor shall comply with all of the QA Inspector instructions to correct deficiencies in materials and workmanship as provided in the contract.

In the event that faulty welding, or its removal for rewelding, damages the base metal so that, in the judgment of the engineer, its retention is not in accordance with the intent of the contract, the contractor shall remove and replace the damaged base metal or shall compensate for the deficiency in an approved manner.

807.05

807.06 MARKING. Heat number markings shall be steel die stamped on main material. Round rods and bar shapes that are shipped, bundled and tagged with heat number from the mill, shall have this heat number transferred and steel die stamped to each piece as it arrives at the fabrication plant in the presence of the Department's inspector when these pieces are main members. Materials for other than main members may be identified by painting heat numbers. Main material used from stock shall show steel die stamped heat numbers along with test reports.

In the fabrication shop, the transferring of heat numbers shall be steel die stamp for all pieces of main material.

Steel die stamping shall be accomplished with low-stress steel stamps having a minimum face character radius of 0.010 inch (250 μ m) and a maximum allowable impression depth of 0.010 inch (250 μ m). Impressions shall be placed on the thickest member in transition joints. Impressions shall not be placed within 1 inch (25 mm) of plate edge.

In case of doubt as to the grade of metal being used, samples will be taken by the inspector for submittal to the Materials and Testing Section for tests to establish the grade.

A color code system in accordance with ASTM A 6 (A 6M) shall be used for all metal. This color shall be placed on material upon entering the shop and carried on all pieces to final fabrication.

Metals not included in ASTM A 6 (A 6M) shall have an individual color code established and on record for the engineer.

807.07 HANDLING AND STORING MATERIALS. Structural material, either plain or fabricated, shall be stored at the shop and project site above ground on platforms, skids or other supports. It shall be kept free from dirt, grease and other foreign matter and protected from corrosion.

Girders and beams shall be placed upright when stored. Long members, such as columns and chords, shall be supported on skids placed near enough together to prevent damage from deflection.

807.08 STRAIGHTENING MATERIAL AND CURVING ROLLED BEAMS AND WELDED GIRDERS.

(a) Straightening Material: Rolled material, before being laid off or worked, shall be straight. If straightening is necessary, it shall be done by methods that will not damage the metal. Heat straightening of AASHTO M 270, Grade 100 (M 270M, Grade 690) and M 270, Grade 100W (M 270M, Grade 690W) steel shall be done only under rigidly controlled procedures,

807.08

each application subject to approval of the engineer. In no case shall the maximum temperature of the steel exceed 1125°F (610°C). Sharp kinks and bends will be cause for rejection of the material. If normalizing is used, straightening of steel plates shall be completed before normalizing operations begin for tension member material. Heat straightening of the material shall only be performed with approval.

(b) Curving Rolled Beams and Welded Girders:

(1) Materials: Steels that are manufactured to a specified yield point greater than 50,000 psi (345 MPa) shall not be heat curved. Heat curving will not be permitted for those portions of girders where span base line curvature is a 200-foot (60 m) radius or less.

(2) Type of Heating: Beams and girders may be curved by either continuous or V-type heating, as approved in accordance with the AASHTO Standard Specifications for Highway Bridges.

807.09 FINISH. Portions of the work exposed to view shall be finished neatly. Shearing, flame cutting and chipping shall be done carefully and accurately and shall be ground to a neat finish.

807.10 BOLT HOLES.

(a) Holes for High Strength Bolts: Holes for bolts shall be either punched or drilled. Material forming parts of a member composed of not more than five plate thicknesses of metal may be punched 1/16 inch (2 mm) larger than the nominal diameter of bolts when the thickness of metal is not greater than 3/4 inch (20 mm) for structural carbon steel or 5/8 inch (15 mm) for alloy steel.

When there are more than five plate thicknesses or when any main material is thicker than 3/4 inch (20 mm) in structural carbon steel or 5/8 inch (15 mm) in alloy steel or when required under Subsection 807.13, holes shall either be drilled full size or subdrilled.

When required under Subsection 807.13, holes shall be either subpunched or subdrilled (subdrilled if thickness limitation governs) 3/16 inch (5 mm) smaller and, after assembling, reamed 1/16 inch (2 mm) larger or drilled full size to 1/16 inch (2 mm) larger than the nominal diameter of bolts.

(b) Oversize or Slotted Holes: When specified or approved, oversize, short-slotted, and long-slotted holes may be used with high strength bolts 5/8 inch (15 mm) and larger in diameter except as hereinafter restricted:

(1) Oversize holes shall be 3/16 inch (5 mm) larger than bolts 7/8 inch (22 mm) and less in diameter, 1/4 inch (6 mm) larger than bolts 1 inch (24

mm) in diameter, and 5/16 inch (8 mm) larger than bolts 1 1/8 inches (30 mm) or greater in diameter. They may be used in all plies of friction-type connections. Hardened washers shall be installed over exposed oversize holes.

(2) Short-slotted holes shall be 1/16 inch (2 mm) wider than the bolt diameter and have a length, which does not exceed the oversize diameter provisions of paragraph (1) above by more than 1/16 inch (2 mm). They may be used in all plies of friction-type or bearing-type connections. The slots may be used without regard to direction of loading in friction type connections, but shall be normal to the direction of the load in bearing-type connections. Hardened washers shall be installed over exposed short-slotted holes.

(3) Long slotted holes shall be 1/16 inch (2 mm) wider than the bolt diameter and have a length more than allowed in paragraph (2) above but not more than 2 1/2 times the bolt diameter.

In friction-type connections, long-slotted holes may be used without regard to direction of loading.

In bearing-type connections, the long diameter of the slot shall be normal to the direction of loading.

Long slotted holes may be used in only one of the connected parts of either a friction-type or bearing-type connection at an individual faying surface.

Structural plate washers or a continuous bar not less than 5/16 inch (8 mm) thick shall be used to cover long slots that are in the outer plies of joints. These washers or bars shall have a size sufficient to completely cover the slot after installation. If hardened washers are required, they shall be placed over the plate or bar.

(4) When enlarged or slotted holes are used, the distances between edges of adjacent holes or edges of holes and edges of members shall not be less than permitted with conventional size holes.

(c) Holes for Other Type Bolts: Holes for ribbed bolts, turned bolts or other approved bearing-type bolts shall be subpunched or subdrilled 3/16 inch (5 mm) smaller than the nominal diameter of bolt and reamed assembled or to a steel template or, after assembling, drilled from the solid.

807.11 PUNCHED HOLES. Diameter of the die shall not exceed diameter of the punch by more than 1/16 inch (2 mm). Holes that must be enlarged to admit bolts shall be reamed. Holes shall be clean-cut without torn or ragged edges. Poor matching of holes will be cause for rejection; any repair shall be subject to approval.

807.12 REAMED OR DRILLED HOLES. Reamed holes shall be cylindrical, perpendicular to the member and not more than 1/16 inch (2 mm) larger than the nominal diameter of bolts. Where practical, reamers and drills shall be directed by mechanical means. Drilled holes shall be 1/16 inch (2 mm) larger than the nominal diameter of bolt. All burrs shall be removed. Poor matching of holes will be cause for rejection. Reaming and drilling shall be done by approved methods. If required, assembled parts shall be taken apart for removal of burrs caused by drilling. Connecting parts requiring reamed or drilled holes shall be assembled and securely held while being reamed or drilled and shall be match-marked before disassembling.

807.13 PREPARATION OF FIELD CONNECTIONS.

(a) Subpunching and Reaming of Field Connections: Holes in field connections and field splices of main members of trusses, arches, continuous beam spans, bents, towers (each face), plate girders and rigid frames shall be subpunched (or subdrilled if required) according to Subsection 807.10 and subsequently reamed while assembled or to a steel template, as required by Subsection 807.17. Holes for floor beam and stringer field end connections shall be subpunched and reamed to a steel template or reamed while assembled. Reaming or drilling full size of field connection holes through a steel template shall be done after template has been located for position and angle and bolted in place. Templates used for reaming matching members, or opposite faces of a single member, shall be exact duplicates. Templates used for connections on like parts or members shall be so accurately located that the parts or members are duplicates and require no match-marking.

For any connection, in lieu of subpunching and reaming or subdrilling and reaming, holes may be drilled full-size with all thicknesses of material assembled in proper position.

(b) Numerically-Controlled Drilled Field Connections:

(1) General: For any connection or splice designated in Subsection 807.13(a), in lieu of subsized holes and reaming while assembled, or drilling holes full-size while assembled, holes may be drilled full-size in unassembled pieces or connections including templates for use with matching subsized and reamed holes by means of suitable numerically-controlled drilling equipment subject to the following provisions.

807.12

If numerically-controlled drilling equipment is used, the engineer may require the contractor, by means of check assemblies, to demonstrate that this drilling procedure consistently produces holes and connections conforming to Subsections 807.15 and 807.17.

The contractor shall submit to the engineer for approval a detailed outline of the proposed procedures to accomplish the work from initial drilling through check assembly, including members that may be numerically-controlled drilled, sizes of holes, location of common index and other reference points, composition of check assemblies and other pertinent information.

(2) Holes: Holes drilled by numerically-controlled drilling equipment shall be drilled to appropriate size either through individual pieces or a combination of pieces held tightly together.

807.14 ACCURACY OF PUNCHED AND DRILLED HOLES. Holes punched full size, subpunched or subdrilled shall be so accurately punched that after assembling (before any reaming is done) a cylindrical pin 1/8 inch (3 mm) smaller in diameter than the nominal size of the punched hole may be entered perpendicular to the face of the member, without drifting, in at least 75 percent of the contiguous holes in the same plane. Failure of a hole to pass a pin 3/16 inch (5 mm) smaller in diameter than the nominal size of punched holes will be cause for rejection.

807.15 ACCURACY OF REAMED AND DRILLED HOLES. When holes are reamed or drilled, 85 percent of the holes in any contiguous group shall, after reaming or drilling, show no offset greater than 1/32 inch (1 mm) between adjacent thickness of metal.

Steel templates shall have hardened steel bushings in holes accurately dimensioned from centerlines of connection as inscribed on the template. Centerlines shall be used in locating the template from milled or scribed ends of members.

807.16 FITTING FOR BOLTING. Contact surfaces of metal shall be prepared as specified in Subsection 807.21(e). Parts of a member shall be assembled, well pinned and firmly drawn together with bolts before drilling or reaming. Assembled pieces shall be taken apart, if necessary, for removal of burrs and shavings produced by reaming. The member shall be free from twists, bends and other deformation.

807.17 SHOP ASSEMBLING. Field connections of main members of trusses, arches, continuous beam spans, bents, towers (each face), plate girders and rigid frames shall be assembled in the shop with milled ends of compression members in full bearing, and then shall have their sub-size holes reamed to specified size while connections are assembled. Unless otherwise specified, assembly shall be Progressive Truss or Girder Assembly.

Check Assemblies with Numerically-Controlled Drilled Field Connections shall be in accordance with Heading (g) of this subsection.

Each assembly, including camber, alignment, accuracy of holes and fit of milled joints, shall be approved before a numerically-controlled drilled check assembly is dismantled.

A diagram shall be furnished to the engineer by the fabricator showing camber at each panel point of trusses or arch ribs, and the location of field splices and fractions of span length (1/4 points minimum, 1/10 points maximum) of continuous beam and girders or rigid frames.

(a) Full Truss or Girder Assembly: Full Truss or Girder Assembly consists of assembling all members of each truss, arch rib, bent, tower face, continuous beam line, plate girder or rigid frame at one time.

(b) Progressive Truss or Girder Assembly: Progressive Girder Assembly shall consist of assembling initially for each arch rib, continuous beam line, or plate girder at least three contiguous shop sections. Progressive Truss Assembly shall consist of assembling initially for each truss, bent, tower face, or rigid frame, all members in at least three contiguous panels, but not less than the number of panels associated with three contiguous chord lengths.

Successive assemblies shall consist of at least one section or panel of the previous assembly (repositioned if necessary and adequately pinned to assure accurate alignment) plus two or more sections or panels added at the advancing end. In the case of structures longer than 150 feet (45 m), each assembly shall not be less than 150 feet (45 m) long regardless of the length of individual continuous panels or sections. At the option of the fabricator, sequence of assembly may start from any location in the structure and proceed in one or both directions so long as the preceding requirements are satisfied.

Assemblies consisting of less than three shop sections or panels shall require approval of the engineer.

(c) Full Chord Assembly: Full Chord Assembly shall consist of assembling, with geometric angles at the joints, the full length of each chord of each truss or open spandrel arch, or each leg of each bent or tower, then reaming their field connection holes while the members are assembled and

807.12

reaming the web member connections to steel templates set at geometric (not cambered) angular relation to the chord line.

Field connection holes in web members shall be reamed to steel templates.

At least one end of each web member shall be milled or scribed normal to the longitudinal axis of the member and the templates at both ends of the member shall be accurately located from one of the milled ends or scribed lines.

(d) Progressive Chord Assembly: Progressive Chord Assembly consists of assembling contiguous chord members in the manner specified for Full Chord Assembly and in the number and length specified for Progressive Truss or Girder Assembly.

(e) Special Girder Assembly: This procedure does not apply to continuous girders, but will be required for rolled beams or plate girders that are part of a simple supported span with a horizontal curve, skewed or superelevated, or any combination thereof.

Special girder assembly consists of assembling rolled beams or plate girders in pairs with all adjacent girders, including floor system, lateral bracing, cross frames, etc. These pairs of beams or girders shall be assembled on blocking, with the proper camber and their relative elevation, in such manner as to ensure proper fittings of all parts during field erection in accordance with any of the previously described methods.

(f) Special Complete Structure Assembly: Special Complete Structure Assembly consists of assembling the entire structure, including the floor system. This procedure is ordinarily needed only for complicated structures such as those having curved girders or extreme skew in combination with severe grade or camber.

(g) Check Assemblies with Numerically-Controlled Drilled Field Connections: A check assembly will be required for each major structural type of each project. It shall consist of at least three contiguous shop sections or, in a truss, all members in at least three contiguous panels but not less than the number of panels associated with three contiguous chord lengths (i.e., length between field splices). Check assemblies shall be based on the proposed order of erection joints in bearings, special points such as portals of skewed trusses and similar considerations.

Use of either geometric angles (giving theoretically zero secondary stresses under dead-load conditions after erection) or cambered angles (giving theoretically zero secondary stresses under no-load conditions) shall be as specified.

The check assemblies shall preferably be the first such sections of each major structural type to be fabricated.

No match-marking and no shop assemblies other than the check assemblies will be required.

Shop drawings shall indicate clearly subpunched holes which are to be reamed assembled or reamed to a template in the shop and all groups of holes which are to be drilled full size with numerically-controlled drills.

If the check assembly fails to demonstrate that required accuracy is being obtained, further check assemblies may be required at no direct pay.

(h) Bearing Assembly: Bearing components shall be completely assembled in the shop and checked to assure accuracy of fit and shall be match-marked for shipping.

807.18 DRIFTING OF HOLES. Drifting done during assembly shall be only such as to bring parts into position and not sufficient to enlarge holes or distort metal. Holes that must be enlarged to admit bolts shall be reamed.

807.19 MATCH-MARKING. Connection parts assembled in the shop for reaming holes in field connections shall be match-marked with steel stencils. A diagram showing such marks shall be furnished to the engineer.

807.20 BOLTS AND BOLTED CONNECTIONS. All bolts shall comply with the requirements of this subsection, except for high strength bolts. Bolted connections fabricated with high strength bolts shall conform to Subsection 807.21.

(a) General: Bolts shall be unfinished, turned or ribbed bolts complying with ASTM A 307, Grade A. Bolts shall have single self-locking nuts or double nuts. Beveled washers shall be used where bearing faces have a slope of more than 1:20 with respect to a plane normal to bolt axis.

(b) Turned Bolts: The surface of the body of turned bolts shall meet the ANSI B 46.1 roughness rating value of 125 μ inches (3.2 μ m). Heads and nuts shall be hexagonal with standard dimensions for bolts of the specified nominal size or the next larger nominal size. Diameter of threads shall be equal to the body of the bolt or the nominal diameter of the bolt. Holes for turned bolts shall be carefully reamed with specified bolts furnished to provide for a light driving fit. Threads shall be entirely outside of holes. A washer shall be provided under the nut.

(c) Ribbed Bolts: The body of ribbed bolts shall be an approved form with continuous longitudinal ribs. The diameter of the body measured on a

807.17

circle through the points of the ribs shall be 5/64 inch (2 mm) greater than the nominal diameter of the specified bolt.

Ribbed bolts shall be furnished with round heads complying with ANSI B18.5. Nuts shall be hexagonal, either recessed or with a washer of suitable thickness. Ribbed bolts shall make a driving fit with the holes. Hardness of the ribs shall be such that the ribs do not mash down enough to permit the bolts to turn in the holes during tightening. If the bolt twists before drawing tight, the hole shall be carefully reamed and an oversized bolt used.

807.21 CONNECTIONS USING HIGH STRENGTH BOLTS.

(a) General: This specification covers the assembly of structural joints using ASTM A 325 (A 325M) or A 490 (A 490M) high strength steel bolts tightened to a high tension. Bolt holes shall be 1/16 inch (2 mm) larger than the nominal bolt size.







All fasteners within a connection shall be of the same type and all bolts within each connection shall be from the same manufacturer.

Construction shall conform to the specifications for welded structures of, carbon structural steel and high strength steel, except as otherwise provided herein.

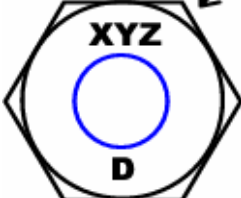
(b) Lock-Pin and Collar Fasteners: When approved, lock-pin and collar fasteners complying with Subsection 1013.08(c) may be used.

(c) Bolts, Nuts and Washers: Bolts shall comply with ASTM A 325 (A 325M) Type 1 or Type 3, or ASTM A 490 (A 490M). Nuts shall comply with ASTM A 563 (A 563M), Grade DH or DH3 or ASTM A 194 (A 194M), Grade 2H. Washers shall comply with ASTM F 436 (F 436M). Marking of bolts, nuts and washers shall comply with Figure 1.

Figure 1

Type	A325 Assembly		A490 Assembly	
	Bolt	A563 Nut	Bolt	A563 Nut
1		Mfr. Identification (typical)  Grade Mark DH, (or 2H)*		 Grade Mark DH or DH3, (or 2H)*
3	 Note Mandatory Underline	 Grade Mark DH3	 Note Mandatory Underline	 Grade Mark DH3

*Grade 2H, plain finish, per ASTM A194 (A194 M).

Type 3 Bolts shall have the "A 325" ("A 325M") and "A 490" ("A 490M") underlined. Type 3 nuts shall have the manufacturers mark and the symbol DH3.

ASTM A 490 (A 490M) bolts shall have the heads marked "A 490" ("A 490M") and shall also identify the manufacturer.

Washers shall be marked by a symbol identifying the manufacturer. Additionally, Type 3 washers shall be identified by the symbol "3."

The minimum bolt length shall be determined by adding the appropriate length given in Table 807-1 to the grip (total thickness of all connected material, excluding washers).

807.21**Table 807-1E
Bolt Length**

Bolt Diameter (inches)	Length to Add to Grip (inches)
1/2	11/16
5/8	7/8
3/4	1
7/8	1 1/8
1	1 1/4
1 1/8	1 1/2
1 1/4	1 5/8
1 3/8	1 3/4
1 1/2	1 7/8

**Table 807-1M
Bolt Length**

Bolt Diameter (mm)	Length to Add to Grip (mm)
M16	20
M20	25
M22	28
M24	30
M27	35
M30	40
M36	50

Nominal bolt and nut dimensions (for informational purposes only) for heavy hex structural bolts and nuts are shown in Table 807-2 and Figure 2.

Table 807-2E
Bolt and Nut Dimensions

Heavy Hex Structural Bolts (Inches)				Heavy Hex Nuts (Inches)	
Nominal Bolt Diameter, D	Width Across Flats, F	Height, H	Thread Length	Width Across Flats, W	Height, H
1/2	7/8	5/16	1	7/8	31/64
5/8	1 1/16	25/64	1 1/4	1 1/16	39/64
3/4	1 1/4	15/32	1 3/8	1 1/4	47/64
7/8	1 7/16	35/64	1 1/2	1 7/16	55/64
1	1 5/8	39/64	1 3/4	1 5/8	63/64
1 1/8	1 13/16	11/16	2	1 13/16	1 7/64
1 1/4	2	25/32	2	2	1 7/32
1 3/8	2 3/16	27/32	2 1/4	2 3/16	1 11/32
1 1/2	2 3/8	15/16	2 1/4	2 3/8	1 15/32

Table 807-2M
Bolt and Nut Dimensions

Heavy Hex Structural Bolts (mm)				Heavy Hex Nuts (mm)	
Nominal Bolt Diameter , D	Width Across Flats, F Min. - Max.	Height, H Min. - Max.	Thread Length For Bolt Lengths >100 mm	Width Across Flats, W Min. - Max.	Height, H Min. - Max.
M16	26.16 - 27.00	9.25 - 10.75	38	26.16 - 27.00	16.4 - 17.1
M20	33.00 - 34.00	11.60 - 13.40	43	33.00 - 34.00	19.4 - 20.7
M22	35.00 - 36.00	13.10 - 14.90	45	35.00 - 36.00	22.3 - 23.6
M24	40.00 - 41.00	14.10 - 15.90	48	40.00 - 41.00	22.9 - 24.2
M27	45.00 - 46.00	16.10 - 17.90	51	45.00 - 46.00	26.3 - 27.6
M30	49.00 - 50.00	17.65 - 19.75	56	49.00 - 50.00	29.1 - 30.7
M36	58.80 - 60.00	21.45 - 23.55	63	58.80 - 60.00	30.0 - 36.6

Figure 2

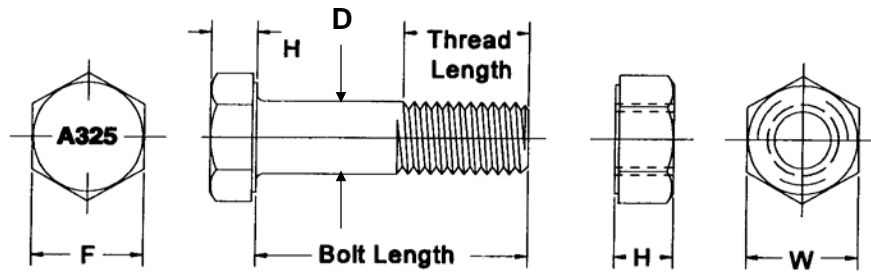

Nuts may be washer faced as shown in Figure 2 or doubled chamfered.

Add 5/32 inch (4 mm) for each hardened flat washer, and add 5/16 inch (8 mm) for each beveled washer. The minimum bolt length thus determined shall be increased to the nearest 1/4 inch (5 mm) for bolt lengths less than 4 inch (100 mm) and to the nearest 1/2 inch (10 mm) for bolt lengths equal to or greater than 4 inch (100 mm) to obtain the required bolt length, but in no case shall the bolt have less than two threads beyond the nut after final torque.

(d) Rotational Capacity Testing:

(1) Rotational-capacity tests are required and shall be performed on all black or galvanized (after galvanizing) bolt, nut, and washer assemblies by the manufacturer or distributor prior to shipping and by the contractor at the job site prior to installation. Washers are required as part of the test.

a. Except as modified herein, the rotational-capacity test shall be performed in accordance with the requirements of ASTM A 325 (A 325M).

b. Each combination of bolt production lot, nut lot and washer lot shall be tested as an assembly. Where washers are not required by the installation procedures, they need not be included in the lot identification.

c. A rotational-capacity lot number shall be assigned to each combination of lots tested.

d. The minimum frequency of testing shall be two assemblies per rotational-capacity lot.

e. The bolt, nut and washer assembly shall be assembled in a Skidmore-Wilhelm Calibrator or an acceptable equivalent device.

f. The minimum rotation, from a snug tight condition (10 percent of the specified proof load), shall be:

240° (2/3 turn) for bolt lengths <4 diameters

360° (1 turn) for bolt lengths >4 diameters and <8 diameters

480° (1 1/3 turn) for bolt lengths >8 diameters

807.21

g. The tension reached at the above rotation shall be equal to or greater than 1.15 times the required installation tension. The installation tension and the tension for the turn test are shown in Table 807-3.

**Table 807-3E
Rotational Capacity Testing**

	Bolt Diameter, inches								
	1/2	5/8	3/4	7/8	1	1 1/8	1 1/4	1 3/8	1 1/2
Required Installation Tension (kips) Proof Load	12	19	28	39	51	56	71	85	103
Turn Test Tension (kips)	14	22	32	45	59	64	82	98	118

**Table 807-3M
Rotational Capacity Testing**

	Bolt Diameter, mm						
	M16	M20	M22	M24	M27	M30	M36
Required Installation Tension (kN) Proof Load	86	139	170	203	238	279	405
Turn Test Tension (kN)	99	160	196	234	274	321	466

h. After the required installation tension listed above has been exceeded, one reading of tension and torque shall be taken and recorded. The torque wrench used shall be a dial type and no multipliers will be allowed. The torque value shall conform to the following:

$$\text{Torque} < 0.25PD \text{ (0.34PD)}$$

Where: Torque = measured torque (foot-pounds) (N·m)

P = measured bolt tension (pounds) (N)

D = bolt diameter (feet) (m)

i. Bolts that are too short to test in a Skidmore-Wilhelm Calibrator may be tested in a steel joint. The tension requirement of Heading (d)(1)g. need not apply. The maximum torque requirement of Heading (d)(1)h. shall be computed using a value of P equal to the turn test tension shown in the table in Heading (d)(1)g.

807.21

(2) Reporting: The results of all tests (including zinc coating thickness) required herein and in the appropriate specifications shall be recorded on the appropriate document. The location where tests are performed and date of tests shall be reported on the appropriate documents.

(3) Witnessing: The tests need not be witnessed by an inspection agency; however, the manufacturer or distributor that performs the tests shall certify that the results recorded are accurate.

(4) Documentation:

a. Mill Test Reports:

1. Mill Test Reports shall be furnished for all mill steel used in the manufacture of the bolts, nuts, or washers.

2. Mill Test Reports shall indicate the place where the material was melted and manufactured.

b. Manufacturer Certified Test Reports:

1. The manufacturer of the bolts, nuts, and washers shall furnish test reports for the item furnished.

2. Each Manufacturer Certified Test Report shall show the information required in accordance with Heading (d)(2).

3. The manufacturer performing the rotational-capacity test shall include the following on the Manufacturer Certified Test Reports.

(a) The lot number of each of the items tested.

(b) The rotational-capacity lot number.

(c) The results of the required tests.

(d) The pertinent information required in Heading (d)(2).

(e) A statement that Manufacturer Certified Test Reports for the items are in compliance with this specification and the appropriate ASTM specifications.

(f) The location where the bolt assembly components were manufactured.

c. Distributor Certified Test Reports:

1. The Distributor Certified Test Reports shall include Manufacturer Certified Test Reports above for the various bolt assembly components.

2. The rotational-capacity test may be performed by a distributor (in lieu of a manufacturer) and reported on the Distributor Certified Test Reports.

3. The Distributor Certified Test Reports shall show the results of the required tests.

4. The Distributor Certified Test Reports shall also show information required in Heading (d)(2).

5. The Distributor Certified Test Reports shall show the rotational-capacity lot number.

6. The Distributor Certified Test Reports shall certify that the Manufacturer Certified Test Reports are in compliance with this specification and the appropriate ASTM specifications.

(5) Shipping:

a. Bolts, nuts and washers (where required) from each rotational-capacity lot shall be shipped in the same container. If there is only one production lot number for each size of nut and washer, the nuts and washers may be shipped in separate containers. Each container shall be permanently marked with the rotational-capacity lot number such that identification will be possible at any stage prior to installation.

b. The appropriate Mill Test Reports, Manufacturer Certified Test Reports, Distributor Certified Test Reports shall be supplied to the Construction Section.

(e) Bolted Parts: Surfaces of bolted parts in contact with the bolt head and nut shall not have a slope of more than 1:20 with respect to a plane normal to bolt axis. Bolted parts shall fit solidly together when assembled and shall not be separated by gaskets or other compressible material. Holes may be punched, subpunched and reamed, or drilled, as required by the applicable specification, and shall be of a nominal diameter not more than 1/16 inch (2 mm) in excess of the nominal bolt diameter.

When assembled, joint surfaces, including those adjacent to the boltheads, nuts or washers, shall be cleaned and prepared in accordance with the following:

(1) When steel is to be painted, contact surfaces within joints shall be cleaned in accordance with Subsection 811.06(b) and painted in accordance with the paint manufacturers written recommendations with an approved inorganic zinc primer. The manufacturer shall provide certified independent test results indicating that the coating, when applied as recommended, shall produce a minimum Class B slip coefficient of 0.50 as specified in AASHTO R 31.

(2) When the plans specify the steel as unpainted AASHTO M 270, Grade 50W (M 270M, Grade 345W), M 270, Grade HPS 50W (M 270M, Grade HPS 345W), M 270, Grade HPS 70W (M 270M, Grade HPS 485W), or M 270, Grade 100W (M 270M, Grade 690W), contact surfaces within joints shall be thoroughly cleaned by Commercial Blast Cleaning in accordance with

Subsection 811.06(c) or other approved methods that will remove all dirt, oil, grease, rust scale, loose mill scale, weld slag and other foreign matter, and shall remain unpainted.

(3) When galvanized steel is specified, after galvanizing and prior to assembly, contact surfaces within joints shall be scored by wire brushing or blasting. Wire brushing treatment shall be a light application of manual or power brushing that marks or scores the surface but removes relatively little of the zinc coating. Blasting treatment shall be a light brush-off treatment which will produce a dull gray appearance. Neither treatment shall be severe enough to produce a break or discontinuity in the zinc surface. When ASTM A 490 (A 490M) bolts are specified to connect galvanized parts, bolts shall be painted to prevent electrolytic action. ASTM A 490 (A 490M) bolts shall not be galvanized.

(4) When contact surfaces within the joint are to be coated with metallized zinc or aluminum, application shall be in accordance with AWS (C2.18), except that subsequent sealing treatments described in Section IV therein shall not be used.

(f) Installation: Bolts shall be installed with a hardened washer under nut or bolt head, whichever is the element turned in tightening. A flat washer may be used when the abutment surface adjacent to the bolt head or nut does not have a slope of more than 1:20 with respect to a plane normal to bolt axis. If an outer face of the bolted part has a slope of more than 1:20 with respect to a plane normal to the bolt axis, a smooth beveled washer shall be used to compensate for lack of parallelism.

ASTM A 490 (A 490M) bolts shall have two hardened washers. ASTM A 490 (A 490M) and ASTM A 325 (A 325M) bolts shall not be reused or retorqued. Retightening previously tightened bolts which have been loosened by tightening adjacent bolts shall not be considered as reuse or retorque.

Fasteners shall be protected from dirt and moisture at the job site. Only as many fasteners as are anticipated to be installed and tightened during a work shift shall be taken from protected storage. Fasteners not used shall be returned to protected storage at the end of the shift. Fasteners shall not be cleaned of lubricant that is present in as-delivered condition.

A direct tension indicator device in accordance with Heading (j) shall be at all job sites where high strength bolts are being installed and tightened. The tension measuring device shall be used to confirm the following:

(1) The conformance to the requirements of Table 807-4 of the complete fastener assembly, including lubrication if required, to be used in construction.

807.21

(2) Calibration of the wrenches, if applicable.

(3) The understanding and proper use by the bolting crew of the method to be used.

The frequency of testing, the number of tests to be performed and the test procedure shall be as specified in Headings (g) through (j) as applicable. A rotational-capacity test shall be conducted at the job site for each lot of bolt, nut, and washer assembly as specified elsewhere herein.

The job inspection torque wrench shall be used to verify that the tightening method used will provide the minimum bolt tension as specified in Table 807-4. The accuracy of the tension measuring device shall be confirmed through calibration by an approved testing agency at least annually.

Fasteners together with washers of size and quality specified shall be installed in properly aligned holes and tightened by the direct tension indicator device method described in Heading (j) to at least the minimum tension specified in Table 807-4 when all the fasteners are tight with the exception that the turn-of-nut tightening method may be used on shop installed bolts. Tightening may be done by turning the bolt while the nut is prevented from rotating when it is impractical to turn the nut. Impact wrenches, if used, shall be of adequate capacity and sufficiently supplied with air to perform the required tightening of each bolt in approximately 10 seconds.

**Table 807-4E
Bolt Tension**

ASTM A 325 BOLTS		
Bolt Diameter (inches)	Minimum Bolt Tension (lb) ¹	Recommended Bolt Tension for Calibrated Wrenches (lb) ²
1/2	12,050	12,500
5/8	19,200	20,000
3/4	28,400	30,000
7/8	39,250	41,000
1	51,500	54,000
1 1/8	56,450	59,000
1 1/4	71,700	75,000
1 3/8	85,450	89,500
1 1/2	104,000	109,000
ASTM A 490 BOLTS		
Bolt Diameter (inches)	Minimum Bolt Tension (lb) ¹	Recommended Bolt Tension for Calibrated Wrenches (lb) ²
1/2	14,900	15,500
5/8	23,700	25,000
3/4	35,100	37,000
7/8	48,500	51,000
1	63,600	67,000
1 1/8	80,100	84,000
1 1/4	101,800	107,000
1 3/8	121,300	127,500
1 1/2	147,500	155,000

¹ Equal to 70 percent of specified minimum tensile strength of bolt.

² Approximately 5 percent in excess of the minimum bolt tension.

**Table 807-4M
Bolt Tension**

ASTM A 325M BOLTS		
Bolt Diameter (mm)	Minimum Bolt Tension (kN) ¹	Recommended Bolt Tension for Calibrated Wrenches (kN) ²
M16	94.2	100
M20	147	160
M22	182	190
M24	212	220
M27	275	290
M30	337	360
M36	490	520
ASTM A 490M BOLTS		
Bolt Diameter (mm)	Minimum Bolt Tension (kN) ¹	Recommended Bolt Tension for Calibrated Wrenches (kN) ²
M16	114	120
M20	179	190
M22	221	230
M24	257	270
M27	334	350
M30	408	430
M36	595	630

¹ Equal to 70 percent of specified minimum tensile strength of bolt.

² Approximately 5 percent in excess of the minimum bolt tension.

(g) Turn-of-Nut Tightening: When turn-of-nut tightening is used, hardened washers are required.

A representative sample of not less than three bolt and nut assemblies of each diameter, length and grade to be used in the work shall be checked at the start of work in a device capable of indicating bolt tension. The test shall demonstrate that the method for estimating the snug tight condition and controlling the turns from snug tight given in Table 807-5 to be used by the bolting crew develops a tension not less than 5 percent greater than the minimum tension in Table 807-4.

Bolts shall be installed in all holes of the connection and brought to a "snug tight" condition. Snug tight is defined as the tightness that exists when the plies of the joint are in firm contact. This may be attained by a few impacts of an impact wrench or the full effort of a man using an ordinary spud wrench.

Snug tightening shall progress systematically from the most rigid part of the connection to the free edges, and then the bolts of the connection shall be retightened in a similar systematic manner as necessary until all bolts are simultaneously snug tight and the connection is fully compacted. Following this initial operation all bolts in the connection shall be tightened further by the tightening operation, there shall be no rotation of the part not turned by the wrench. Tightening shall progress systematically from the most rigid part of the joint to its free edges.

(h) Calibrated Wrench Tightening:

(1) Calibrated wrench tightening may be used only when required by the plan or directed by the engineer. Calibration shall be on a daily basis and a hardened washer shall be used under the element turned in tightening. This specification does not recognize standard torques determined from tables or from formulas, which are assumed to relate torque to tension.

When calibrated wrenches are used for installation, they shall be set to provide a tension not less than 5 percent nor more than 25 percent in excess of the minimum tension specified in Table 807-4. The installation procedures shall be calibrated at least once each working day for each bolt diameter, length and grade using the following.

a. The length of air hose that will be used and the fastener assemblies that are being installed in the work. Calibration shall be accomplished in a device capable of indicating actual bolt tension by tightening three typical bolts of each diameter, length and grade from the bolt being installed and with a hardened washer from the washers being used in the work under the element turned in tightening.

b. The bolts, nuts and washers used for calibration one time may be used in the structure. Wrenches shall be recalibrated when significant differences are noted in the surface condition of the bolts threads, nuts or washers.

When calibrated wrenches are used to install and tension bolts in a connection, bolts shall be installed with hardened washers under the element turned in tightening bolts in all holes of the connection and brought to a snug tight condition. Following this initial tightening operation, the connection shall be tightened using the calibrated wrench. Tightening shall progress systematically from the most rigid part of the joint to its free edges. The wrench shall be returned to touch up previously tightened bolts which may have been relaxed as a result of the subsequent tightening of adjacent bolts until all bolts are tightened to the prescribed amount.

(2) Job Inspection Torque Wrench: A manual job inspection torque wrench will be calibrated in a device capable of indicating bolt tension. Five bolts of each diameter, length and type to be used will be installed in a tension indicating device and tensioned to 10 percent of the minimum required bolt tension (snug tight). Tightening shall then continue with the job inspection torque wrench to the minimum required bolt tension. The torque required to produce the minimum and recommended bolt tension specified in Table 807-4 shall be recorded. For each torque range, the low and the high values will be discarded and the remaining three values averaged. The average torque needed to provide the minimum bolt tension shall be the job inspection torque and the average torque needed to provide the recommended bolt tension shall be the maximum job torque.

(i) Installation of Alternate Design Bolts: When fasteners which incorporate a design feature intended to indirectly indicate the bolt tension or to automatically provide the tension required by Table 807-4 and which have been qualified under Heading (f) are to be installed, a representative sample of not less than three bolts of each diameter, length and grade shall be checked at the job site in a device capable of indicating bolt tension. The test assembly shall include flat hardened washers, if required in the actual connection, arranged as in the actual connections to be tensioned. The calibration test shall demonstrate that each bolt develops a tension not less than 5 percent greater than the minimum tension required by Table 807-4. The manufacturer's installation procedure as required by Heading (f) shall be followed for installation of bolts in the calibration device and in all connections.

When alternate design fasteners which are intended to control or indicate bolt tension of the fasteners are used, bolts shall be installed in all holes of the connection and initially tightened sufficiently to bring all plies of the joint into firm contact but without yielding or fracturing the control or indicator element of the fasteners. All fasteners shall then be further tightened, progressing systematically from the most rigid part of the connection to the free edges in a manner that will minimize relaxation of previously tightened fasteners. In some cases, proper tensioning of the bolts may require more than a single cycle of systematic partial tightening prior to final twist-off of the control or indicator element of individual fasteners.

(j) Direct Tension Indicator Devices: When direct tension indicator devices are used, a representative sample of not less than three devices for each diameter and grade of fastener to be used in the work shall be assembled in a calibration device capable of indicating bolt tension. The test assembly

807.21

shall include flat hardened washers arranged as those in the actual connections to be tensioned. The calibration test shall demonstrate that the device indicates a tension not less than 5 percent greater than the minimum given in Table 807-4.

Manufacturer's installation procedure as required by Heading (f), if appropriate, shall be followed for installation of bolts in the calibration device and in all connections. Special attention shall be given to proper installation of flat hardened washers when direct tension indicator devices are used with bolts installed in oversize or slotted holes and when the load indicating devices are used under the turned element.

When bolts are installed using direct tension indicators meeting the requirements of ASTM F 959 (F 959M), bolts shall be installed in all holes of the connection and brought to snug tight condition. Snug tight is indicated by partial compression of the direct tension indicator protrusions. All fasteners shall then be tightened, progressing systematically from the most rigid part of the connection to the free edges in a manner that will minimize relaxation of previously tightened fasteners. In some cases, proper tensioning of the bolts may require more than a single cycle of systematic partial tightening prior to final tightening to deform the protrusion to the specified gap.

(k) Inspection: Before the installation of fasteners in the work, the engineer will check the marking, surface condition and storage of bolts, nuts and washers and the faying surfaces of joints for compliance with the requirements of these specifications.

The engineer shall observe calibration and/or testing procedures required in Headings (f) through (j), as applicable, to confirm that the selected procedure is properly used and that, when so used with the fastener assemblies supplied, the tensions specified in Table 807-4 are provided. He shall monitor the installation of fasteners in the work to assure that the selected procedure, as demonstrated in the initial testing to provide the specified tension, is routinely properly applied.

(1) Inspection of bolts installed by tightening method of Heading (j), Direct Tension Indicator (DTI) devices, shall be as follows:

The DTI washers of all bolts will be visually inspected to ensure that the washer protrusions are deformed to approximate final position.

A 0.005 inch (125 μ m) Feeler gage will be used on 10 percent of the bolts in a connection, but not less than two bolts, to verify the washer gap conforms to the manufacturers recommendations. If all inspected bolts meet manufacturers requirements, the connection is accepted. If any of the inspected bolts fail to meet the manufacturers requirements, all bolts in the

connection will be checked with feeler gage and any bolts not sufficiently tightened shall be re-tightened and reinspected. Should inspection reveal excessive tightening, the contractor will be required to adjust the installation procedure to correct this situation. This will not be cause to replace bolts.

(2) Inspection of bolts installed by tightening methods of Headings (g), (h), and (i) shall be as follows:

One bolt from each connection shall be selected and the job inspection wrench shall be applied with sufficient torque to set the bolt or nut in motion. The torque shall be noted and the torque shall be greater than the job inspection torque, but less than the maximum job torque as determined during calibration.

Bolts will be inspected by applying the job inspection torque wrench to 10 percent of the bolts, but not less than two bolts, selected by the engineer at random in each connection. If no nut or bolt head is turned by application of the job inspection torque, the connection shall be accepted as properly tightened. If a nut or bolt head is turned by the application of less than the job inspection torque, this torque will be applied to all bolts in the connections, and all bolts whose nut or head is turned by less than the specified torque shall be tightened and reinspected; or the fabricator or contractor may retighten all bolts in the connection and resubmit the connection for inspection.

807.21

**Table 807-5
Nut Rotation from Snug Tight Condition¹**

Bolt Length (Measured from underside of head to extreme end of point)	Disposition of Outer Faces of Bolted Parts		
	Both faces normal to bolt axis	One face normal to bolt axis and other face sloped not more than 1:20 (bevel washer not used)	Both faces sloped not more than 1:20 from normal to bolt axis (bevel washers not used)
Up to and including 4 diameters	1/3 turn	1/2 turn	2/3 turn
Over 4 diameters but not exceeding 8 diameters	1/2 turn	2/3 turn	5/6 turn
Over 8 diameters but not exceeding 12 diameters ²	2/3 turn	5/6 turn	1 turn

¹Nut rotation is relative to bolt, regardless of the element (nut or bolt) being turned. For bolts installed by 1/2 turn and less, the tolerance is ± 30 degrees; for bolts installed by 2/3 turn and more, the tolerance is ± 45 degrees.

²When bolt lengths exceed 12 diameters, the required rotation must be determined by actual test in a suitable tension device simulating actual conditions.

The procedures for inspecting and testing lock-pin and collar fasteners and their installation for required preload tension shall be as approved. The contractor shall provide the personnel and required job inspection torque wrench for the engineer to perform the inspection specified herein. The job inspection torque wrench will be calibrated by the Materials and Testing Section.

807.22 PLATE CUT EDGES.

(a) Edge Planing: Sheared edges of plates more than 5/8 inch (15 mm) thick and carrying calculated stress shall be planed, milled, ground or thermal cut to a depth of 1/4 inch (6 mm). Reentrant corners shall be filleted to a minimum radius of 3/4 inch (20 mm) before cutting.

(b) Visual Inspection and Repair of Plate Cut Edges: Visual inspection and repair of plate cut edges shall be in accordance with Section 3.2.3 of the latest edition of ANSI/AASHTO/AWS D1.5 (D1.5M) Bridge Welding Code.

807.23

807.23 SHOP WELDING. Shop welding of metal structures shall comply with Section 815.

807.24 ORTHOTROPIC-DECK BRIDGES.

(a) Protection of Deck Plate After Sandblasting: If sandblasting to white metal, or an equivalent method, is used to prepare the deck plate to receive a wearing surface, a protective coating shall be applied to the plate immediately after cleaning.

(b) Dimensional Tolerance Limits: Dimensional tolerance limits for orthotropic-deck bridge members shall be applied to each completed but unloaded member and shall be as specified in latest AASHTO specifications except as otherwise provided herein. The deviation from detailed flatness, straightness or curvature at any point shall be the perpendicular distance from that point to a template edge having the detailed straightness of curvature and which is in contact with the element at two other points. The term "element" as used herein refers to individual panels, stiffeners, flanges or other pieces. The template edge may have any length not exceeding the greatest dimension of the element being examined and, for any panel, not exceeding 1.5 times the least dimension of the panel; it may be placed anywhere within the element. The deviation shall be measured between adjacent points of contact of the template edge with the element; the distance between these adjacent points of contact shall be used in formulas to establish the tolerance limits for the segment being measured when this distance is less than the applicable dimension of the element specified for the formula.

(1) Flatness of Panels: The term "panel" as used herein means a clear area of steel plate surface bounded by stiffeners, webs, flanges or plate edges and not further subdivided by any such elements. These provisions apply to all panels in the bridge; for plates stiffened on one side only, such as orthotropic-deck plates or flanges of box girders, this includes the total clear width on the side without stiffeners as well as the panels between stiffeners on the side with stiffeners.

The maximum deviation from detailed flatness of curvature of a panel shall not exceed the greater of:

$$3/16 \text{ inch or } D/144\sqrt{T} \quad (5\text{mm or } D/28.6\sqrt{T})$$

where: D = least dimension in inches (mm) along boundary of panels, and
T = minimum thickness in inches (mm) of plate comprising the panel.

(2) Straightness of Longitudinal Stiffeners Subject to Calculated Compressive Stress, Including Orthotropic-Deck Ribs:

Maximum deviation from detailed straightness or curvature in any direction perpendicular to its length of a longitudinal stiffener subject to calculated compressive stress, including orthotropic-deck rib, shall not exceed:

$$L/480 \quad (L/12,192)$$

where: L = length of stiffener or rib between cross members, webs or flanges, in inches (mm).

(3) Straightness of Transverse Web Stiffeners and Other Stiffeners not Subject to Calculated Compressive Stress:

Maximum deviation from detailed straightness or curvature in any direction perpendicular to its length of a transverse web stiffener or other stiffener not subject to calculated compressive stress shall not exceed:

$$L/240 \quad (L/6096)$$

where: L = length of stiffener or rib between cross members, webs or flanges in inches (mm).

807.25 FACING OF BEARING SURFACES. The surface of bearing and base plates and other bearing surfaces that are to come in contact with each other or with concrete shall comply with the surface finish of Table 807-6 and ANSI B 46.1, Surface Roughness, Waviness and Lay, Part 1:

**Table 807-6
Bearing Surface Finish**

Surface	Surface Finish
Steel slabs	2,000 μ inches (50 μ m)
Heavy Plates in contact in shoes to be welded	1,000 μ inches (25 μ m)
Milled ends of compression members, stiffeners, and fillers	500 μ inches (12.5 μ m)
Bridge rollers and rockers	250 μ inches (6.3 μ m)
Pins and pin holes	125 μ inches (3.2 μ m)
Sliding bearings	125 μ inches (3.2 μ m)
All other surfaces	500 μ inches (12.5 μ m)

807.26 ABUTTING JOINTS. Abutting joints in compression members, girder flanges and tension members, when specified, shall be faced and brought to an even bearing. When joints are not faced, the opening shall not exceed 1/4 inch (6 mm).

807.27 END CONNECTION ANGLES. Floor beams, stringers and girders having end connection angles shall be built to specified length (+0, -1/16 inch) (+0, -2 mm) between heels of connection angles. If continuity is required, end connections shall be faced. Thickness of connection angles shall not be less than 3/8 inch (10 mm) nor less than that shown on the plans after facing.

807.28 LACING BARS. Ends of lacing bars shall be neatly rounded.

807.29 FABRICATION OF MEMBERS. Steel plates for main members and splice plates for flanges and main tension members, not secondary members, shall be cut and fabricated so that the primary direction of rolling is parallel to the direction of the main tensile and compressive stresses. Fabricated members shall be true to line and free from twists, bends and open joints.

807.30 BENT PLATES. Unwelded, cold-bent, load-carrying, rolled steel plates shall be so taken from the stock plates that the bend line will be at right angles to the direction of rolling, except that cold-bent ribs for orthotropic-deck bridges may be bent in the direction of rolling if permitted.

Bending shall be such that no cracking of the plate occurs. Minimum bend radii, measured to the concave face of the metal, are shown in Table 807-7.

**Table 807-7
Steel Plate Bending Radius**

Plate Thickness, t Inches (mm)	Minimum Bend Radius
Up to 1/2 (15)	2 t
Over 1/2 to 1 (15 to 25)	2 1/2 t
Over 1 to 1 1/2 (25 to 40)	3 t
Over 1 1/2 to 2 1/2 (40 to 65)	3 1/2 t
Over 2 1/2 to 4 (65 to 100)	4 t

Low alloy steel over 1/2 inch (15 mm) thick may require hot bending for small radii.

Allowance for springback of AASHTO M 270, Grade 100 (M 270M, Grade 690), and M 270, Grade 100W (M 270M, Grade 690W) steel should be about three times that for structural carbon steel. For brake press forming, the lower die span should be at least 16 times the plate thickness. Multiple hits are advisable.

If shorter radii are essential, plates shall be bent hot at a temperature not greater than 1150°F (620°C), except for AASHTO M 270, Grade 100 (M 270M, Grade 690) , and M 270, Grade 100W (M 270M, Grade 690W) steel. If AASHTO M 270, Grade 100 (M 270M, Grade 690) , and M 270, Grade 100W (M 270M, Grade 690W) steel plates to be bent are heated to a temperature greater than 1125°F (610°C), they must be requenched and tempered in accordance with the producing mill's practice. Hot-bent plates shall conform to the requirements herein for cold-bent plates.

Before bending, corners of the plate shall be rounded to a radius of 1/16 inch (2 mm) throughout the portion of the plate at which bending is to occur.

807.31 FIT OF STIFFENERS. End stiffeners of girders and stiffeners intended as supports for concentrated loads shall have full bearing (either milled, ground or welded, as specified) on the flanges. Stiffeners not intended to support concentrated loads shall have a tight fit. As an alternate, stiffeners may be cut short, jammed to the tension flange and seal-welded to the compression flange. Fillers under stiffeners shall fit within 1/4 inch (6 mm) at each end. Welding transversely across tension flanges of beams or girders will not be permitted unless shown on the plans.

807.32 EYEBARS. Fabrication for eyebars shall comply with the latest AASHTO specifications.

807.33 STRESS RELIEVING. When specified, members such as bridge shoes, pedestals or other parts which are built up by welding sections of plate together shall be stress-relieved in accordance with AWS.

807.34 PINS AND ROLLERS. Pins and rollers shall be accurately turned to specified dimensions and shall be straight, smooth and free from flaws.

Pins and rollers more than 9 inches (230 mm) in diameter shall be forged and annealed. Pins and rollers 9 inches (230 mm) or less in diameter may be either forged and annealed or cold-finished carbon-steel shafting.

In pins larger than 9 inches (230 mm) in diameter, a hole not less than 2 inches (50 mm) in diameter shall be bored full length along the axis after the forging has been allowed to cool to a temperature below the critical range under suitable conditions to prevent damage by too rapid cooling and before being annealed.

807.35 BORING PIN HOLES. Pin holes shall be bored true to specified diameter, smooth and straight, at right angles with the axis of the member and parallel with each other. The final surface shall be produced by a finishing cut.

The distance outside-to-outside of end holes in tension members, and inside-to-inside of end holes in compression members shall not vary from that specified more than 1/32 inch (1 mm). Boring of holes in built-up members shall be done after connections are completed.

807.36 PIN CLEARANCES. Pin hole diameter shall not exceed pin diameter by more than 0.020 inch (0.5 mm) for pin diameters of 5 inches (125 mm) or less, and 0.03125 inch (0.80 mm) for larger pins.

807.37 SCREW THREADS. Threads for bolts and pins for structural steel construction shall comply with the Unified Standard Series UNC/ANSI B1.1, Class 2A for external threads and Class 2B for internal threads, except that pin ends having a diameter of 1 3/8 inches (35 mm) or more shall have six threads per inch (per 25 mm).

807.38 PILOT AND DRIVING NUTS. Two pilot nuts and two driving nuts for each size pin shall be furnished.

807.39 CAMBER FOR ROLLED BEAMS IN SIMPLE SPAN. When specified, beams shall be cambered to conform to the vertical curve or level grade required after full dead load is applied. Camber shall approximate a simple curve from end to end of beam. The camber ordinate at midlength of the beam shall be equal to the dead load deflection of the beam plus the midordinate of the vertical curve, if the span is on a vertical curve. The camber ordinate may vary from the above by $\pm 1/4$ inch (± 6 mm).

Beams may be cambered cold or may be heated. When heat is used, the tension flange shall be heated uniformly and progressively to not more than a red heat visible in ordinary shop light (1150°F) (620°C) while the beam is loaded to produce compression in the bottom flange. The contractor shall furnish pyrometers or temperature-indicating crayons for checking the desired temperatures. Heating and loading shall be done in such manner that the permanent camber remaining shall be within the limits specified above. After cambering, the beam shall be left to air cool and no quenching process shall be permitted.

807.35

807.40 STRAIGHTENING OF MEMBERS. Cooling with water will not be allowed without permission.

807.41 ARMORED JOINTS. Armored joint assemblies shall be paired and fitted before shipping. Plates, angles or other structural shapes shall be accurately shaped at the shop to conform to the specifications covering those items. Care shall be taken to ensure that the surface in the finished plane is true and free of warping. Positive methods shall be employed in placing the joints to keep them in correct position during placing of concrete. The opening at expansion joints shall be that designated on the plans at normal temperatures, and care shall be taken to avoid impairment of the clearance.

807.42 SHEAR CONNECTORS. Shear connectors may be either 3/4 inch (19 mm) or 7/8 inch (22 mm) studs. Stud shear connectors shall comply with the requirements of Section 7, Stud Welding of the latest edition of ANSI/AASHTO/AWS/D1.5 (D1.5M) Bridge Welding Code.

807.43 MARKING AND SHIPPING. Unless otherwise specified, girders and beams shall be placed in the upright position for shipment. Each member shall be painted or marked with an erection mark for identification and an erection diagram shall be furnished with erection marks shown thereon.

The contractor shall furnish to the engineer as many copies of material orders, shipping statements and erection diagrams as directed. Weights of individual members shall be shown on the statements. Members weighing more than three tons (2500 kg) shall have weights marked thereon. Structural members shall be loaded in such manner that they may be transported and unloaded at their destination without being excessively stressed, deformed or otherwise damaged.

Pins, small parts and packages of bolts, washers and nuts shall be shipped in boxes, crates, kegs or barrels, but the gross weight of any package shall not exceed 300 pounds (135 kg). A list and description of the contained materials shall be plainly marked on the outside of each shipping container.

807.44 PAINTING. Shop and field paints and their application shall comply with Section 811.

807.45 FALSEWORK. Falsework shall be designed in accordance with Subsection 801.04.

807.46 BEARINGS AND ANCHORAGES. Bearings shall be set level, in exact position, and shall have full and even bearing on the masonry. Bearings shall not be placed on masonry bearing areas which are irregular or improperly formed.

(a) Elastomeric Bearing Pads: If used, elastomeric bearing pads shall be set directly on the concrete masonry.

(b) Cast Iron or Steel or Rolled Steel Bearings: Cast iron or steel or rolled steel bearings shall be bedded on the masonry with a preformed fabric bearing pad.

(c) PTFE Sliding Plate Bridge Bearings: When polytetrafluorethylene (PTFE) sliding plate bridge bearings are specified on the plans, they shall comply with the following requirements.

Sliding plate bearings shall be fabricated by companies and shops normally engaged in production of bridge bearings similar to the types specified. Structural steel components shall comply with AASHTO M 270, Grade 36 or Grade 50 (M 270M, Grade 250 or 345). Fabrication and erection of bearings shall comply with Section 807 as amended herein.

Anchor bolts shall be grouted in preformed wells in the top of existing piers. Grout shall be an approved non-shrink, non-metallic type complying with Subsection 1018.26.

Sliding surfaces shall be stainless steel operating against a bearing surface of PTFE. Such bearing shall be structurally equal to those shown on the plans and shall be designed to accommodate all required movements and reactions.

(1) Construction Methods: Before fabrication of bearings, the contractor shall submit shop drawings for approval.

After fabrication and before bonding, stainless steel or PTFE back-up material shall be planed to a true plane. Bonding of PTFE sheets shall be performed at the factory of the bearing manufacturer under controlled conditions and in accordance with written instructions of the adhesive system manufacturer. Side of PTFE sheet to be bonded to metal shall be factory treated by an approved manufacturer by the sodium naphthalene or sodium ammonia process.

After bonding operations, the PTFE surface shall be smooth, flat and free from bubbles. Filled PTFE surfaces shall then be polished. Fabric shall be capable of carrying unit loads of 10 ksi (70 MPa) without cold flow. PTFE fabric shall be bonded or mechanically attached to a rigid substrate.

807.46

The fabric-substrate bond shall be capable of withstanding a shear force equal to 10 percent of the perpendicular application loading without delamination in addition to the shear force developed as a result of the natural bearing frictions shear force. The test method shall comply with ASTM D 1002.

Welding to steel plate which has bonded PTFE surface will be permitted providing a welding procedure is established and approved which restricts temperature reached by bond area to less than 300°F (150°C) as determined by temperature indicating wax pencils or other suitable means.

The clad plate shall comply with ASTM A 264. In lieu of the clad plate the stainless steel plate may be continuously Tungsten Inert Gas Fillet Welded to the sole plate.

The back-up plate for the PTFE surface shall be factory vulcanized to the lower neoprene bearing element.

Where unfilled PTFE sheet is used, PTFE shall be recessed in backup plate by 1/2 the PTFE sheet thickness.

Bearings shall be assembled at the plant, marked for identification and delivered as a complete unit. Bearings shall have permanent match-marks to indicate the normal position of the bearing. During transportation and storage, bearings shall be covered with moisture proof and dust-proof covers, and shall be protected against damage.

The contractor shall furnish manufacturer's certification of steel, elastomeric pads, PTFE and other materials used in fabrication of bearings.

(2) Fabrication Inspection: Fabrication will be inspected by the Construction Section in accordance with Section 807.05 as amended herein.

Tests for coefficient of friction shall be performed by the manufacturer or in an approved laboratory. One completed bearing shall be tested from each group. Test methods and equipment shall be approved and shall include, but shall not be limited to, the following:

a. Tests shall be arranged so that the coefficient of friction of first movement of bearing can be determined.

b. Bearing surfaces shall be cleaned prior to testing and a silicon gel may be added to the surfaces. When silicon gel is used between the bearing surfaces during the test, silicon gel shall be applied to each bearing either before assembly at the fabrication plant or before erection in the field.

c. Tests shall be conducted at maximum working stress for the PTFE working surface with test load supplied continuously for 12 hours prior to measuring friction.

d. First movement static and dynamic coefficients of friction of test bearings shall be determined at a sliding speed of less than 1 inch (25 mm) per minute and shall not exceed 75 percent of the coefficient of friction specified in Table 807-8.

Table 807-8
Coefficient of Friction of Bearing

	Bearing Pressure ¹		
	500 psi (3.5MPa)	2000 psi (14MPa)	3500 psi (24MPa)
	Coefficient of Friction		
Unfilled PTFE, Fabric containing PTFE fibers, and PTFE-Perforated Metal			
Composite	0.08	0.06	0.04
Filled PTFE	0.12	0.10	0.08

¹The actual bearing pressure shall be provided to the fabricator upon request.

e. Bearing specimens shall then be subjected to 100 movements of at least 1 inch (25 mm) of relative movement and if the test facility permits, full design movement at a speed of less than 1 foot (300 mm) per minute. Following this test, static and dynamic coefficients of friction shall be determined again and shall not exceed values measured in Heading (d) above. Bearing specimen shall show no appreciable sign of bond failure or other defects.

Bearings represented by test specimens passing above requirements will be approved subject to onsite inspection for visible defects.

807.47 STRAIGHTENING BENT MATERIAL AND CAMBERING.

(a) Straightening Bent Material: Straightening of plates, angles, other shapes and built-up members, when permitted, shall be done by methods that will not produce fracture or other damage. Distorted members shall be straightened by mechanical means or, if approved, by supervised application of a limited amount of localized heat, except that heat straightening of AASHTO M 270, Grade 100 (M 270M, Grade 690), and M 270, Grade 100W (M 270M, Grade 690W) steel shall be done only under rigidly controlled procedures, each application subject to approval of the engineer. In no case shall the maximum temperature of AASHTO M 270, Grade 100 (M 270M, Grade 690), and M 270, Grade 100W (M 270M, Grade 690W) steel exceed 1125°F (610°C), nor shall the temperature exceed 950°F (510°C) at weld

807.46

metal or within 6 inches (150 mm) of weld metal. Heat shall not be applied directly on weld metal. In all other steels, the temperature of the heated area shall not exceed 1150°F (620°C) (a dull red) as controlled by temperature indicating crayons, liquids or bi-metal thermometers.

Parts to be heat straightened shall be substantially free of stress from external forces, except stresses resulting from mechanical means used in the application of heat.

Following the straightening of a bend or buckle, the surface of the metal shall be carefully inspected for evidence of fracture.

(b) Cambering: Correction of errors in camber in welded beams and girders of AASHTO M 270, Grade 100 (M 270M, Grade 690), and M 270, Grade 100W (M 270M, Grade 690W) steel shall be done only under rigidly controlled procedures, each application subject to approval.

807.48 ASSEMBLING STEEL. Parts shall be accurately assembled and any match-marks shall be followed. Materials shall be carefully handled so that no parts will be bent, broken or otherwise damaged. Hammering which will damage or distort members shall not be done. Bearing surfaces and surfaces to be in permanent contact shall be cleaned before members are assembled.

Unless erected by the cantilever method, truss spans shall be erected on blocking so placed as to give the trusses proper camber. Blocking shall be left in place until tension chord splices are fully riveted or bolted and all other truss connections pinned and bolted. Rivets or permanent bolts in splices of butt joints of compression members and rivets or permanent bolts in railings shall not be driven or tightened until the span has been swung.

Splices and field connections shall have at least 50 percent of the holes filled with bolts and pins (either erection or untorqued permanent bolts) and at least 10 percent of cylindrical erection pins for fit-up and alignment. Splices and connections carrying traffic during erection shall have 75 percent of the holes filled. Main member splices shall have all holes filled with bolts and cylindrical erection pins (half bolts and half pins) for fit-up and alignment.

Fit-up bolts shall be of the same nominal diameter as rivets or permanent bolts and cylindrical erection pins shall be 1/32 inch (1 mm) larger.

Permanent field bolting shall be performed in accordance with Subsection 807.21.

807.49 PIN CONNECTIONS. Pilot and driving nuts shall be used in driving pins. They shall be furnished by the contractor without charge. Pins

shall be so driven that the members will take full bearing on them. Pin nuts shall be tightened and the threads burred at the face of the nut.

807.50 FIELD WELDING. Field welding of steel structures, when authorized, shall comply with Section 815.

807.51 MISFITS. Correction of minor misfits involving harmless amounts of reaming, cutting and chipping will be considered a legitimate part of erection. However, any error in fabrication or deformation resulting from handling and transportation which prevents proper assembling and fitting of parts by moderate use of drift pins or reaming and slight chipping or cutting, shall be reported immediately to the inspector and approval of the method of correction obtained. The correction shall be made in the presence of the inspector. The contractor shall be responsible for the correction of all misfits, errors and damages and shall make the necessary corrections and replacement at no direct pay.

807.52 WEATHERING STEEL. When AASHTO M 270, Grade 50W (M 270M, Grade 345W), M 270, Grade HPS 50W (M 270M, Grade HPS 345W), M 270, Grade HPS 70W (M 270M, Grade HPS 485W), or M 270, Grade 100W (M 270M, Grade 690W) weathering steel is specified to be left unpainted, the following modifications in the requirements of this subsection shall apply.

(a) Materials: Steel to be completely embedded in concrete shall be either AASHTO M 270, Grade 36 or Grade 50W (M 270M, Grade 250 or 345W) steel. Anchor bolt assemblies and other steel partially embedded in concrete shall be AASHTO M 270, Grade 50W (M 270M, Grade 345W) steel.

(b) High Strength Bolts: High strength bolts shall be ASTM A 325, Type 3 (A 325M, Type 3).

(c) Stiffeners: To facilitate drainage adjacent to stiffeners, the lower end of transverse stiffeners shall be clipped at least 1 1/2 inches (40 mm), and longitudinal stiffeners shall be terminated at least 1 inch (25 mm) short of transverse stiffeners.

(d) Cleaning of Exposed Surfaces: Exposed surfaces of weathering steel to be left unpainted shall be cleaned of all grease, oil, paint or other soilage.

Outside surfaces of exterior girders and the bottom surface of the bottom flange of exterior girders shall be blast cleaned, either before or after erection, in accordance with Subsection 811.06(b). All other exposed surfaces of

807.46

weathering steel shall be blast cleaned in accordance with Subsection 811.06(c). Blast cleaned surfaces shall be kept free of grease, oil, markings, paint or other soilage; such soilage of blast cleaned surfaces shall be removed by approved methods. Concrete splatter shall be washed off immediately. The first 10 feet (3 m) of weathering steel girders adjacent to expansion joints shall

be painted with the standard zinc paint except that the top coat color shall match the color of the weathered steel.

(e) Restoration of Concrete Finish: All concrete surfaces requiring a Class 2A finish shall be restored to the required finish at the time of final acceptance.

807.53 MEASUREMENT.

(a) Weight Basis: Structural steel will be measured by the weight (mass) of metal in pounds (kg) remaining in the completed and accepted structures. The weight will be computed on the basis of theoretical net weight from the approved shop drawings. No allowance will be made for bolts, nuts, washers or welds and no deductions will be made for bolt holes, beam copings, cut flanges or edge preparation for welding. Deduction will be made for pin holes. Plates shall be estimated from the sizes billed and deductions made for cut corners. Shear connectors will not be measured for payment.

No measurement of structural steel of any class will be allowed for temporary work or for additional weight (mass) in members provided for erection purposes.

No allowance will be made in the pay quantity for any items not remaining in the finished structure, except as hereinafter provided.

No allowance will be made for shop or field paints, galvanizing or other coatings.

No allowance will be made for overrun on plates or rolled sections.

When full-size tests of built-up structural members and eyebars are required, any fullsize members tested to destruction will be measured if the test proves satisfactory. However, if the test proves unsatisfactory, the members represented by it will be rejected and no measurement or allowance will be made for such members.

AASHTO M 270, Grade 36 (M 270M, Grade 250) steel shall include all metal classified as such in the plans and specifications and such minor items as anchor materials including pins, rollers, metal railings, steel plates and shapes for expansion joints, ladders, checkered floor plates, bronze castings and plates, steel and iron castings (except cast iron drains in floors) ladders,

stairways, platforms, structural supports and brackets for machinery and power equipment including pit pumps, steel framework for counterweights, floor plates, keeper plates and their tap bolts, sheet metal covers for gears and drum switches and other parts, shim plates, bearing plates for approach spans, curb angles, anchor bolts including those for roadway gates, and bronze and cast iron for expansion plates.

AASHTO M 270, Grade 36 (M 270M, Grade 250), M 270, Grade 50 (M 270M, Grade 345), M 270, Grade 50W (M 270M, Grade 345W), M 270, Grade HPS 50W (M 270M, Grade HPS 345W), M 270, Grade HPS 70W (M 270M, Grade HPS 485W), M 270, Grade 100 (M 270M, Grade 690), or M 270, Grade 100W (M 270M, Grade 690W) steel shall include all steel classified as such in the plans or specifications.

Metal weights (masses) will be computed on the bases of Table 807-9:

Table 807-9
Metal Unit Weights (Mass)

Metal	Unit Wt (lb/cu ft.)	Unit Mass (kg/cu m)
Aluminum, cast or wrought	173.0	2770
Bronze, cast	536.0	8590
Copper-alloy	536.0	8590
Copper, sheet	558.0	8940
Iron, cast	445.0	7130
Iron, malleable	470.0	7530
Iron, wrought	487.0	7800
Lead, sheet	707.0	11320
Steel, rolled, cast, copper bearing, silicon, nickel, and stainless	490.0	7850
Zinc	450.0	7210

(b)Lump Sum Basis: When payment is specified to be made by the lump sum, no weight (mass) measurement of metal will be made. Any estimate of the weight (mass) of structural metalwork shown on the plans is approximate and no guarantee is made that it is the correct weight (mass) of each grade of metal to be furnished. It is the contractor's responsibility to determine the correct weight (mass) of each grade of metal furnished. No adjustment in contract price will be made due to errors in the estimated weight (mass) shown on the plans. Shop bills will not be required.

807.53

807.54 PAYMENT.

(a) Weight (Mass) Basis: Payment for the various classifications of structural metals will be made at the respective contract unit prices per pound (kg).

(b) Lump Sum Basis: Payment for the completed and accepted items will be made at the contract lump sum price, which includes furnishing, fabricating, erecting, painting, galvanizing or other coating of all necessary materials; furnishing all required labor, plants, equipment, tools, staging, falsework, forms, power welding, bolts, all bearings described in Subsection 807.46 and other hardware; and the performance of all work necessary to complete the item.

When changes in the work are ordered by the engineer, which vary the weight (mass) of steel to be furnished, the lump sum payment will be adjusted as follows:

The value per pound (kg) of the increase or decrease in the weight (mass) of structural steel involved in the change will be determined by dividing the contract lump sum amount by the estimated weight (mass) shown on the plans. The adjusted contract lump sum payment will be the contract lump sum amount plus or minus the value of the steel involved in the change, and no additional compensation will be made on account of said change.

If a change in the grade of steel to be furnished is ordered by the engineer, resulting in additional cost to the contractor, compensation will be made in accordance with Subsection 109.04.

Payment will be made under:

Item No.	Pay Item	Pay Unit
807-01	Steel (AASHTO M 270, Grade 36) (M 270M, Grade 250)	Pound (kg)
807-02	Steel (AASHTO M 270, Grade 50) (M 270M, Grade 345)	Pound (kg)
807-03	Steel (AASHTO M 270, Grade 50W) (M 270M, Grade 345W)	Pound (kg)
807-04	Steel (AASHTO M 270, Grade HPS 50W) (M 270M, Grade HPS 345W)	Pound (kg)
807-05	Steel (AASHTO M 270, Grade HPS 70W) (M 270M, Grade HPS 485W)	Pound (kg)
807-06	Steel (AASHTO M 270, Grade 100) (M 270M, Grade 690)	Pound (kg)
807-07	Steel (AASHTO M 270, Grade 100W) (M 270M, Grade 690W)	Pound (kg)
807-08	Structural Metalwork	Lump Sum

Section 808

Steel Grid Flooring

808.01 DESCRIPTION. This work consists of furnishing and installing steel grid flooring of the open or concrete-filled type, as specified, in accordance with these specifications and in reasonably close conformity with the details shown on the plans.

Before fabrication or construction is undertaken, the contractor shall submit shop and assembly details in accordance with Subsection 801.03.

808.02 MATERIALS. Steel grid flooring shall comply with Subsection 1013.21.

Concrete in filled steel grid floors shall be Class A complying with Section 901, except Grade F coarse aggregate shall be used.

Paint shall comply with Section 811.

808.03 FABRICATION. Deviations from these specifications to conform to manufacturer's specifications will not be permitted without approval of the Bridge Design Engineer.

Upper edges of members forming the wearing surface of open type grid flooring shall be fabricated or treated to give maximum skid resistance.

808.04 NOTICE OF BEGINNING OF WORK. The contractor shall give the DOTD Chief Construction Engineer at least 10 days advance written notice of the beginning of work at the mill or shop so that inspection may be provided. No material shall be manufactured or work done in the shop before shop drawings have been approved and before the DOTD Chief Construction Engineer has been notified.

808.05 FACILITIES FOR INSPECTION. The contractor shall furnish facilities for inspection of material and workmanship in the mill and shop as described in Subsections 807.04 and 807.05.

808.06 STORAGE OF MATERIALS. Steel grid flooring shall be stored as specified in Subsection 807.07.

808.07 STRAIGHTENING MATERIAL. Steel grid flooring sections, before being installed, shall be straight, except for camber if specified. If straightening is necessary, it shall be done by methods that will not damage the metal.

808.08 ARRANGEMENT OF SECTIONS. Where main elements are normal to centerline of roadway, the units generally shall be of such length as to extend over the full width of roadway for roadways up to 40 feet (12 m), but in every case the units shall extend over at least three panels. Where joints are required, ends of main floor members shall be welded at joints over their full cross-sectional area or otherwise connected to provide continuity.

Where main elements are parallel to centerline of roadway, sections shall extend over at least three panels, and ends of abutting units shall be welded over their full cross-sectional area or otherwise connected to provide continuity.

808.09 PROVISION FOR CAMBER. Steel units so rigid that they will not readily follow the camber required shall be cambered in the shop. To provide a bearing surface parallel to the crown of the roadway, stringers shall be canted or provided with shop-welded beveled bearing bars. If beveled bars are used, they shall be placed along the centerline of stringer flange, in which case the design span length shall be governed by width of bearing bar instead of width of stringer flange.

Longitudinal stringers shall be mill-cambered or provided with bearing strips so that the complete floor, after deadload deflection, shall conform to the required longitudinal camber.

808.10 FIELD ASSEMBLY. Areas of considerable size shall be assembled before the floor is welded to its supports. Main elements shall be made continuous and sections shall be connected along their edges by welding. Connections will be subject to approval.

808.11 CONNECTION TO SUPPORTS. The floor shall be connected to its steel supports by welding. Before welding, the floor shall either be loaded to make a tight joint with full bearing or clamped down. Location, length and size of welds shall be subject to approval of the Bridge Design Engineer, but in no case shall they be less than the manufacturer's standards.

808.11

Ends of main steel members of the slab shall be securely fastened together at the sides of the roadway for the full length of span by steel plates or angles welded to ends of main members.

808.12 WELDING. Shop and field welding shall comply with Section 815. Field welding shall comply with the approved method and location as shown on the shop drawings.

808.13 PROTECTIVE COATING. Unless otherwise specified, the steel grid floor shall be hot dipped galvanized in accordance with Section 811.

808.14 CONCRETE FILLER. When specified, concrete filler shall be placed in the open grid.

Floor types with bottom flanges not in contact shall be provided with bottom forms of metal to retain the concrete filler.

Metal forms shall fit tightly on bottom flanges of floor members and be placed in short lengths so as to extend only about 1 inch (25 mm) onto the edge of each support, and in all cases forms shall provide for adequate bearing of the slab on the support.

Concrete shall be consolidated by vibrating the steel grid floor. The vibrating device and manner of operating it will be subject to approval.

808.15 MEASUREMENT. The quantity of steel grid flooring for payment will be the design area as specified on the plans and adjustments thereto. Design quantities will be adjusted if the engineer makes changes to adjust to field conditions, if plan errors are proven or if design changes are necessary.

Concrete for filling steel grid flooring will not be measured for payment.

808.16 PAYMENT. Payment for steel grid flooring will be made at the contract price per square foot (sq m), which includes furnishing and fabricating all steel materials, including base plates, trim angles, trim plates, galvanizing or other coating (if required) and all welding and bolting, and any additional materials or fabrication in the floor system necessitated by the use of an approved alternate grid flooring type.

Payment will be made under:

Item No.	Pay Item	Pay Unit
808-01	Steel Grid Flooring	Square Foot (Sq m)

Section 809

Movable Bridges

809.01 DESCRIPTION. This work consists of furnishing, fabricating and erecting movable span bridges and all appurtenances required for their operation such as machinery, operating house, traffic barriers, and machinery houses.

The requirements for fixed span bridges, as given elsewhere in these specifications, shall apply to movable span bridges unless specified otherwise in this section.

809.02 GUARANTEES. Prior to final acceptance of the project, the contractor shall furnish warranties and guarantees as specified in Subsection 104.05.

809.03 BOND. The contractor will be required to furnish satisfactory bonding in accordance with Subsection 103.05.

809.04 DRAWINGS. Shop drawings, brochures and work drawings shall be furnished in accordance with Subsection 801.03.

809.05 MAINTENANCE AND OPERATION MANUALS. Maintenance and operation instruction manuals shall be furnished in accordance with Subsection 801.03(e)(2).

809.06 INSTRUCTION TO DEPARTMENTAL PERSONNEL. The contractor shall notify the engineer when the span, including the power plant, operating house, traffic barriers and machinery, is fully operational in order that the permanent bridge operators may be assigned for instruction. At this time the contractor shall furnish a person experienced in operation of the equipment for 5 working days of 8 hours each to instruct the Department's bridge operators in the complete and correct operation of the bridge and to provide complete instruction to the Department's electrical, mechanical and bridge maintenance personnel in proper operation, maintenance, lubrication and adjustment of equipment. Prior to beginning the instruction period the contractor shall prepare an instruction guide and submit it to the Bridge Design Engineer for approval. The guide shall describe the instructions to be given

809.06

the Department's operators and maintenance personnel. Items of instruction shall be listed and spaces provided for the project engineer to check off the item as it is completed. The completed guide shall be included in the maintenance manual. This 5-day period of instruction shall be prior to final inspection.

809.07 METALS. Structural and miscellaneous metals used in the manufacture of parts for movable bridges shall be as listed in Sections 1012 and 1013 and the current AASHTO Standard Specifications for Movable Highway Bridges.

809.08 WIRE ROPE, COUNTERWEIGHT ROPE, AND ATTACHMENTS. Wire rope and attachments shall comply with Subsections 1009.10 and 1009.11.

809.09 GENERAL FABRICATION AND ERECTION REQUIREMENTS. Except as otherwise provided herein, the fabrication and erection of structural parts shall conform to Section 807.

809.10 MANUFACTURE AND FABRICATION OF MACHINERY AND TRAFFIC BARRIERS.

(a) Shop Practice: The manufacture of machined parts shall be in accordance with ANSI standards for the various items. For surface finish requirements refer to ANSI B 46.1.

(b) Inspection: The contractor shall give the DOTD Chief Construction Engineer 10 days advance written notice before beginning the manufacture of any item, so that inspection may be provided. The contractor shall furnish facilities for inspection of material and workmanship as described in Subsections 807.04 and 807.05. Inspectors shall be allowed free access to plant facilities for adequate inspection of the work. This inspection shall be at the option of the Department and shall not relieve the contractor of any responsibility placed upon him by the contract.

(c) Fit Tolerances for Accurate Work: Fits for machinery parts shall be in accordance with ANSI Standards B4.1 for English measure (referred to hereafter as ABC measure: American, British, Canadian conference agreement) and B4.2 for metric (ISO) measure. Tables of Preferred Fits are provided in the referenced Standards that give allowances and tolerances for diameters up to 20 inches (500 mm). For larger sizes the preferred fits can be calculated from other data from within the standards. Allowances are based

upon the use of the hole as the nominal size and give the amounts by which the shaft should be less than or greater than the basic (ISO) or nominal (ABC) hole size. Fits classifications and recommended fits for typical mating parts are tabulated in Table 809-1.

(d)Description of Standard Fit Classifications (ISO): The classes of fits are arranged in three general groups: clearance fits, transition fits, and interference fits.

(1) Clearance fits:

a. H11/c11 *Loose running fits* are intended for wide commercial tolerances or allowances on external members.

b. H9/d9 *Free running fits* are not intended for use where accuracy is essential, but good for large temperature variations, high running speed, or heavy journal pressure.

c. H8/f7 *Close running fits* are intended for running on accurate machines and for accurate location at moderate speeds and journal pressures.

d. H7/g6 *Sliding fits* are not intended to run freely, but to move and turn freely and locate accurately.

e. H7/h6 *Locational clearance fits* are intended to provide snug fits for locating stationary parts; but can be freely assembled and disassembled.

(2) Transition fits:

a. H7/k6 *Locational transition fits* are intended for more accurate location, it is a compromise between clearance and interference.

b. H7/n6 *Locational transition fits* are intended for more accurate location where greater interference is permissible.

(3) Interference fits:

a. H7/p6 *Locational interference fits* are intended for parts requiring rigidity and alignment with prime accuracy of location but without special bore pressure requirements.

b. H7/s6 *Medium drive fits* are intended for ordinary steel parts or shrink fits on light sections, the tightest fits usable with cast iron.

c. H7/u6 *Force fits* are intended for parts which can be highly stressed or for shrink fits where the heavy pressing forces required are impractical.

(e) Description of Standard Fit Classifications (ABC): The classes of fits are arranged in three general groups: running and sliding fits, locational fits, and force fits.

(1) Running and Sliding Fits (RC): Running and sliding fits are intended to provide a similar running performance, with suitable lubrication allowance, throughout the range of sizes. The clearances for the first two classes, used chiefly as slide fits, increase more slowly with the diameter than for the other classes, so that accurate location is maintained even at the expense of free relative motion.

a. RC₁ *Close sliding fits* are intended for the accurate location of parts which must assemble without perceptible play.

b. RC₂ *Sliding fits* are intended for accurate location, but with greater maximum clearance than class RC₁. Parts made to this fit move and turn easily but are not intended to run freely, and in the larger sizes may seize with small temperature changes.

c. RC₃ *Precision running fits* are about the closest fits which can be expected to run freely, and are intended for precision work at slow speeds and light journal pressures, but are not suitable where appreciable temperature differences are likely to be encountered.

d. RC₄ *Close running fits* are intended chiefly for running fits on accurate machinery with moderate surface speeds and journal pressures, where accurate location and minimum play is desired.

e. RC₅ and RC₆ *Medium running fits* are intended for higher running speeds, or heavy journal pressures, or both.

f. RC₇ *Free running fits* are intended for use where accuracy is not essential, or where large temperature variations are likely to be encountered, or under both these conditions.

g. RC₈ and RC₉ *Loose running fits* are intended for use where wide commercial tolerances may be necessary, together with an allowance, on the external member.

(2) Locational Fits (LC, LT, and LN): Locational fits are fits intended to determine only the location of the mating parts; they may provide rigid or accurate location, as with interference fits, or provide some freedom of location, as with clearance fits. Accordingly, they are divided into three groups: clearance fits (LC), transition fits (LT), and interference fits (LN).

a. LC *Locational clearance fits* are intended for parts which are normally stationary, but which can be freely assembled or disassembled.

They range from snug fits for parts requiring accuracy of location, through the medium clearance fits for parts such as spigots, to the looser fastener fits where freedom of assembly is of prime importance.

b. LT *Locational transition fits* are a compromise between clearance and interference fits, for application where accuracy of location is important, but either a small amount of clearance or interference is permissible.

c. LN *Locational interference fits* are used where accuracy of location is prime importance, and for parts requiring rigidity and alignment with no special requirements for bore pressure. Such fits are not intended for parts designed to transmit frictional loads from one part to another by virtue of the tightness of fit, as these conditions are covered by force fits.

(3) Force Fits (FN): Force or shrink fits constitute a special type of interference fit, normally characterized by maintenance of constant bore pressures throughout the range of sizes. The interference therefore varies almost directly with diameter, and the difference between its minimum and maximum value is small, to maintain the resulting pressures within reasonable limits.

a. FN₁ *Light drive fits* are those requiring light assembly pressures, and produce more or less permanent assemblies. They are suitable for thin sections or long fits, or in cast-iron external members.

b. FN₂ *Medium drive fits* are suitable for ordinary steel parts, or for shrink fits on light sections. They are about the tightest fits that can be used with high-grade cast-iron external members.

c. FN₃ *Heavy drive fits* are suitable for heavier steel parts or for shrink fits in medium sections.

d. FN₄ and FN₅ *Force fits* are suitable for parts which can be highly stressed, or for shrink fits where the heavy pressing forces required are impractical.

(f) Fits for Common Mating Parts: Recommended fits for common mating parts are shown in Table 809-1.

809.10

**Table 809-1
Recommended Fits for Common Mating Parts**

Part	Fit	
	ABC	ISO
Shaft Journals	RC4	H8/f7
Journal Bushing	RC4	H8/f7
Split Bushing in Base	LC2	H7/h6
Solid Bushing in Base (≤ 0.25 inch wall (6 mm wall))	LN2	H7/p6
Solid Bushing in Base (> 0.25 inch wall (6 mm wall))	FN2	H7/s6
Hubs on Shafts	FN2	H7/s6
Hubs on Main Trunnions (≤ 10 inches diam. (254 mm diam.))	FN4	H7/u6
Hubs on Main Trunnions (> 10 inches diam. (245 mm diam.))	FN2	H7/s6
Turned Bolts in Finished Holes	LC2	H7/h6
Sliding Bearings	RC4	H8/f7
Keys and Key Ways (top and bottom)	LC2	H7/h6
Keys and Key Ways (sides)	FN2	H7/s6

(g)Surface Finishes: Surface finishes shall be in accordance with ANSI Standard B46.1. Recommended surface finishes for common machinery parts are shown in Table 809-2.

Table 809-2
Recommended Surface Finishes for Common Machinery Parts

Part	Finish	
	ABC ($\mu\text{in.}$)	ISO (μm)
Machinery Base on Steel	250	6.3
Machinery Base on Masonry	500	12.5
Shaft Journals	8	0.2
Journal Bushing	16	0.4
Split Bushing in Base	125	3.2
Solid Bushing in Base	63	1.6
Hubs on Shafts (≤ 2 inches/50mm bore)	32	0.8
Hubs on Shafts (> 2 inches/50mm bore)	63	1.6
Hubs on Main Trunnions	63	1.6
Turned Bolts in Finished Holes	63	1.6
Sliding Bearings	32	0.8
Center Discs	32	0.8
Keys and Key Ways	63	1.6
Machinery Parts in Fixed Contact	125	3.2
Teeth of Open Spur Gears:		
Under 1 inch circular pitch (Under 25mm module)	32	0.8
1 inch circular pitch to 1.75 inches circular pitch (25mm module to 44mm module)	63	1.6
Over 1.75 inches circular pitch (Over 44mm module)	125	3.2

809.11 TRUNNIONS, SHAFTS AND JOURNALS. Trunnions and shafts shall be made with fillets where abrupt changes in section occur.

Journals of trunnions and shafts shall be polished to ANSI 8 $\mu\text{in.}$ (0.2 μm) surface finish after being machined. Fillets shall be polished to ANSI 63 $\mu\text{in.}$ (1.6 μm) surface finish in the direction of turning. For trunnions and shafts more than eight inches (200 mm) in diameter, a hole approximately 1/5 the diameter of shaft or trunnion shall be bored lengthwise through the center.

809.12 COUPLINGS. Faces of flange couplings shall be planed to an ANSI 125 $\mu\text{in.}$ (3.2 μm) surface finish and holes bored in pairs.

809.13 HUBS. Hubs of wheels, pulleys, gears and couplings shall be bored true to center for a medium drive fit upon their shafts or axles. Ends of hubs shall be finished as required.

809.14 BUSHINGS. Bushings shall be bored to fit the matching shaft or journal to within the tolerances specified.

809.14

The bearing housing shall be bored to fit the outside of the bushing. Contact edges of oil grooves and bushings shall be rounded.

Babbitt metal, when required shall be poured in the bearing in such a way that the thickness of the bushing after boring will be uniform.

809.15 BEARING HOUSING. Rubbing and bearing surfaces shall have an ANSI 16 $\mu\text{in.}$ (0.4 μm) surface finish and the joints between cap and base of bearings shall have an ANSI 125 $\mu\text{in.}$ (3.2 μm) finish. Holes in cap and base shall be drilled. Holes in bearings, for bolts fastening them to their supports, shall be drilled or reamed to size for turned bolts as required in Subsection 809.21. Holes in the supports shall be reamed to fit after bearings have been adjusted. Bearings shall be finished on both ends. Trunnion bearings shall be bored parallel with the base.

809.16 GEAR TEETH. Gear teeth transmitting power for operation of the bridge shall be machine cut. The periphery and ends of teeth shall be turned. The pitch circle shall be scribed on the teeth. Rack teeth may be either cast or cut and finished.

Open gears shall be fabricated to AGMA 390.03 standard and AGMA Gear Quality Number 6 or 7.

809.17 BEVEL GEARS. Bevel gear teeth shall be cut by a planer having a rectilinear motion in lines through the apex of the cone. Rotating milling cutters shall not be used for making bevel gears.

Open bevel gears shall be fabricated to AGMA 390.03 and AGMA Gear Quality Number 6 or 7.

809.18 WORMS AND WORM WHEELS. Threads on worms shall be machine cut and worm wheel teeth shall fit the worm accurately with surface or line contact.

Open worms and worm wheels shall be fabricated to AGMA 390.03 and AGMA Gear Quality Number 6 or 7.

809.19 MAIN DRIVE SPEED REDUCERS. The speed reducer units shall be manufactured in accordance with the requirements of the American Gear Manufacturers Association (AGMA) and shall carry the AGMA symbol on the nameplate. Reducers shall be rated for the minimum acceptable service factor shown on the plans or as recommended by the reducer manufacturer.

Speed reducer bearings shall be anti-friction type with a B-10 life of 40,000 hours. Gear quality shall be Class 7 and backlash shall meet AGMA standards based on center distance.

Lubrication of gears shall be oil immersion type. Provisions shall be made for filling, draining, and ventilating the housing and a sight gauge shall be mounted on the unit in a position where the lubricant level can be observed. Oil tight shaft seals and/or stuffing boxes shall be provided.

Reducer units shall be filled to fill plug level with synthetic oil as recommended by the reducer manufacturer.

The gear housing shall completely enclose the gears and shall be oil tight, gasketed, and removable.

809.20 KEY AND KEYWAYS. Keys shall be planed and keyways machine cut. Finish of keys and keyways shall give the key a locational clearance fit on the top and bottom and medium drive fit on the sides. Tapered keys shall bear on the top, bottom and sides; parallel faced keys on side only.

809.21 CASTINGS. Castings shall be cleaned and fins and other irregularities removed. Contact surfaces of castings to be attached to structural steel or other castings shall have an ANSI 250 $\mu\text{in.}$ (6.3 μm) finish. Unfinished edges of bases, ribs and similar parts shall be neatly cast with rounded corners. Inside angles shall have proper fillets. Bosses shall be finished to the correct plane. Surfaces of castings in contact with masonry shall have an ANSI 2000 $\mu\text{in.}$ (50 μm) finish.

809.22 BOLT HOLES, MACHINE BOLTS AND TURNED BOLTS. Holes for unfinished bolts 1/2 inch (13 mm) diameter or larger, inclusive, shall be drilled or reamed not more than 1/16 inch (2 mm) larger in diameter than the bolt. Holes for unfinished bolts less than 1/2 inch (13 mm) diameter shall be drilled or reamed not more than 1/32 inch (1 mm) larger in diameter than the bolt. Diameter of the shank of turned bolts shall be of such size as to make a locational clearance fit for the holed parts.

809.23 BRAKES AND BRAKE LININGS. Brake shoes or bands shall be made so as to bear uniformly on the brake wheel. Brake linings shall be attached to the shoes by copper rivets or approved bonding and in such manner as to be easily accessible for replacement.

809.24

809.24 RACK AND TRACK. In swing bridges, track segments shall be finished on the top and at ends to an ANSI 250 $\mu\text{in.}$ (6.3 μm) finish. The track centerline shall be scribed on the surface.

Tooth segments forming the rack shall be fitted accurately and installed to AGMA 390.03 and AGMA Gear Quality Number 6 or 7. Care shall be taken to have the pitch of teeth at joints accurate and continuous. Tips of rack teeth shall be machine finished to a true circle. The pitch line shall be scribed on teeth.

Backs of racks which bear on metal surfaces and surfaces in contact with them shall be finished to an ANSI 1000 $\mu\text{in.}$ (25 μm) finish. Surfaces which bear on masonry shall have an ANSI 2000 $\mu\text{in.}$ (50 μm) finish.

809.25 PIVOT BEARING SEATS. Seats shall be finished to ensure a horizontal position of the span.

809.26 PIVOT BEARINGS. Discs for pivot bearings shall be fitted accurately, finished to gage and ground accurately to final finish. The sliding contact surface of steel and phosphor-bronze discs shall be given an ANSI 8 $\mu\text{in.}$ (0.2 μm) finish. Disc centers shall be assembled, fitted accurately and match-marked.

When specified, rolling element bearings shall be furnished for the pivot. Rolling bearings shall be accurately fitted to the pivot jacket and top. The rotating parts shall be shop assembled and the alignments confirmed. The bearing pivot base and pivot top shall be shipped to the site as an assembly.

809.27 BALANCE WHEELS. The periphery and faces of balance wheels shall be turned to an ANSI 250 $\mu\text{in.}$ (6.3 μm) finish, corners shall be rounded and the centerline of the balance wheels shall be scribed on the periphery. Hubs shall be bored accurately and faced on both ends.

809.28 PLANING GIRDERS. In-built track girders and segmental girders of rolling bascule bridges, the edges of webs, side plates and angles shall be given an ANSI 250 $\mu\text{in.}$ (6.3 μm) finish.

809.29 TREAD PLATES AND TRACK SEGMENTS. Contact surfaces of tread plates and track segments shall be given an ANSI 250 $\mu\text{in.}$ (6.3 μm) finish.

809.30 OIL OR GREASE GROOVES IN TRUNNION BEARINGS. Oil or grease grooves in trunnion bearing surfaces shall be machine cut. After machining, small imperfections may be removed by filing and honing. Grooves shall be smooth, especially the rounded corners.

809.31 BORING AND ASSEMBLY OF TRUNNION BEARINGS. Trunnion bearings to be mounted on flexible supports shall be so bored that when the trunnion girder or support deflects under full dead load, the axes of trunnions will be coincident.

Trunnions shall be fitted to their bearings in the manufacturer's shop. If they are to be disassembled for shipment, they shall be match-marked for field erection.

809.32 SHEAVES. Grooves in sheaves shall be turned. The shape of grooves shall conform as closely as feasible to the rope section so that while ropes run freely in the grooves, the sides of grooves shall prevent wire ropes from flattening under static loads, as when supporting counterweights. Segmental sheaves shall be completely assembled and, if of welded construction, shall be stress relieved before grooves are turned. Variation from required diameter shall not exceed 0.01 inch (25 μm).

Sheaves shall have a force fit on shafts up to and including 10 inches (250 mm), and a medium drive fit on shafts over 10 inches (250 mm).

Both ends of hub shall be finished as specified.

809.33 HOLES FOR SHEAVE BEARINGS. In vertical lift bridges, holes in girders and columns for bolts connecting main sheave bearings to their supporting members shall be drilled from the solid through cast iron or steel templates on which the bearings were set and accurately aligned when holes in the bearings are bored. Bolt holes and bolts shall be the same diameter. Bolts shall be driven in place without damage to bolts, bearings, girders or columns.

809.34 SHOP ASSEMBLY OF MACHINERY. When specified, machinery parts shall be assembled in the shop on their structural supports. They shall be aligned, adjusted and fitted in their correct relative positions and holes in structural supports shall be drilled to correctly match the holes in machinery parts. Parts shall be match-marked before disassembling and shall be erected in the field in the same relative positions.

809.24

When specified, the complete center of swing spans, including rack and track segments, shall be assembled in the shop and aligned, fitted, drilled and the parts match-marked. When specified, the complete gear train shall be assembled in the shop and subjected to a specified time run.

When assembling in the shop is not required, holes in structural supports shall be left blank to be drilled in the field after machinery parts have been set to correct alignment and adjustment or subpunched or drilled 1/4 inch (6 mm) smaller and reamed to size after erection.

Hydraulic power units shall be shop assembled. When specified, hydraulic system components shall be shop assembled into modules. Power units and modules shall be shipped to the bridge site as assemblies after testing. Power units and modules shall be tested in the shop and certified test data submitted to the Bridge Design Engineer. No hydraulic assemblies shall be shipped to the site without test data approval. The contractor shall submit to the bridge design engineer a test plan for approval 2 weeks before the anticipated test date. This submittal shall also serve as notification of the test so that the department may provide an inspector. This inspection shall be at the option of the Department and does not relieve the contractor of any of responsibilities in the contract.

809.35 HYDRAULIC PIPING. Inside of the hydraulic piping shall be bright, clean and free from grease, drainage compounds, oxide, scale and carbon deposits. Any pipe which has been pickled to remove scale shall be treated to eliminate pickle brittleness. The inside of the pipe shall then be coated with clean oil and ends of the pipe sealed for protection against corrosion during shipment and storage. The corrosion preventive oil used shall be such that after extended storage periods, it can be readily removed with an alkaline cleaning solution. Welding of hydraulic pipe shall comply with Section 815.

Hydraulic fluid shall be as specified on the plans. Hydraulic fluid shall be filtered whenever added to the system either for tests, addition of make-up fluid, or original and final system filling. The degree of filtration shall be as specified on the plans.

809.36 PROTECTION OF MACHINERY, POWER PLANT AND TRAFFIC BARRIER PARTS DURING SHIPMENT. Finished rubbing and bearing surfaces of machinery and traffic barrier parts shall be given a protective coating before shipment. Bearing surfaces of trunnions, heavy

axles and shafts, in addition to the protective coating, shall be protected by wood lagging securely attached.

Bearing surfaces of other shafts, axles and similar parts shall be covered with burlap or other satisfactory protecting material. Small machinery and traffic barrier parts shall be boxed or crated.

Electrical equipment and apparatus shall be protected by boxes or crates. Electric motors not designed to be operated fully exposed to the weather shall be protected by waterproof coverings.

Hydraulic equipment fluid ports shall be securely sealed prior to shipment and shall remain sealed until final assembly of the hydraulic system. Seals shall not be removed until just before the connection of components.

Modular and power unit components shall be properly supported to prevent damage to flanged joints.

809.37 ERECTION.

(a) Position of Span During Erection: Movable bridges may be erected in either the open or closed position, as approved by navigation authorities and the engineer.

(b) Protection of Machinery, Operator House and Traffic Barrier Parts During Erection: Parts that are protected from weather in the completed structure or during shipment from the shop shall also be protected during unloading, field storage and erection. Care shall be exercised in protecting electrical parts. Wire ropes shall be stored above ground and free from conditions likely to produce corrosion of wires or decay of fiber cores. While being unwound or otherwise handled during installation, wire ropes shall not be kinked or bent to short radius curves nor dragged over stones, rough metal surfaces or other material likely to produce abrasions on exposed surfaces of the wires.

(c) General Requirements for Machinery and Traffic Barrier Erection: Alignment and adjustment of machinery, electrical equipment and traffic barriers shall be done by skilled mechanics. Trunnion bearings and important shaft bearings shall be set using piano wire or optical methods to determine their correct adjustment. Alignment of the gear train shall be in accordance with AGMA 390.03.

Shims shall be of sheet steel and brass shim stock. The contractor shall have a supply of shims varying in size and thickness with a minimum thickness of 0.003 inch (75 μm). Shims shall be used for aligning and adjusting machinery to its proper place prior to securing it rigidly in position

809.24

with bolts or other fastenings. Brass shim stock shall be used for final adjustment. All shims shall be sized to provide full bearing.

Flanges on hydraulic systems shall be welded so that there is no visible deviation from the normal to the pipe axis.

Bolted flange connections on hydraulic piping systems shall be evenly assembled by use of feeler gauges and torque wrenches to ensure equal bolt tightening.

Minor pockets and depressions formed as a result of erection and which may collect moisture or oil shall be drained provided that none of the parts drained are weakened by the drainage openings.

(d)Lubrication: Rotating and sliding parts shall be thoroughly lubricated during erection. All parts shall be properly lubricated before operating machinery is tested. Counterweight and operating ropes shall be given one coat of an approved lubricant.

(e) Camber, General Requirements: When movable bridges are being erected, care shall be taken to set camber blocking to the necessary heights, so that the span will be assembled to proper camber curves when structural parts are unstressed. When the camber blocking is struck and spans swung, all joints shall be 100 percent pinned and bolted so that no slippage will occur at connections.

(f) Camber for Swing Spans: When swing spans are erected on camber blocking, blocking shall be set to such elevation as to fulfill the requirements of the plans.

(g)Alignment of Bascule Leaves: Trusses or girders of a bascule span erected in an open position shall be held to correct alignment and position with struts, braces and guys. When required, punching of laterals shall be left blank until the bridge is lowered to permit adjustment of alignment to ensure correct closing and locking.

(h)Alignment and Trunnion Bearings: When full deflection of trunnion girders or bearing supports occur under full dead load, the axes of trunnions shall be coincident.

(i) Alignment of Vertical Lift Spans: Towers and guides shall be vertical when the dead load of the span and counterweight has been applied.

(j) Pressure Testing of Hydraulic Piping Systems: Hydraulic piping systems, after installation but before connection to power units and assemblies, shall be pressure tested in accordance with the plans.

(k) Testing and Adjusting of the Moving Span Operation: The contractor shall test and adjust the moving span operation according to the

procedures set forth on the plans. These tests shall not take place until the moving span is completely constructed and all installation and testing of the individual electrical and mechanical components have been completed.

The contractor shall provide qualified technicians familiar with the mechanical and electrical systems to be tested and fully capable of making the required adjustments. The contractor shall provide the necessary tools, equipment, and measuring devices needed to perform the systems testing and adjusting.

After final adjustments are completed service test of power operation of the span shall be made by moving the span through a number of complete open and close cycles. The number of cycles required will be determined by the engineer. These cycles of movement shall be executed in succession without intervals of rest between them. Defects in the operation of the span shall be corrected.

After completion of the final tests of hydraulic systems, the hydraulic fluid shall be removed, properly discarded, replaced with new fluid, in-line filter elements replaced and air bled from the entire system.

(l) Barriers: Vertical lifting barriers shall be balanced to provide a counterweight heavy condition throughout the entire travel.

(m) End Lifts for Hydraulic Swing Spans: The final grade of the approach slab shall not be set until the end lift mechanism has been tested and determined to be capable of lifting the moving span to the desired final grade elevation under the conditions set forth in the plans. Adjustments in the approach slab may be required if the mechanism proves incapable of working to the nominal elevation.

809.38 COUNTERWEIGHTS. Counterweights shall be sufficient to balance the moving span and its attachments in any position, except that on vertical lift bridges, balancing for the counterweight ropes may not be required.

Counterweights shall be made adjustable so that variations in the weight of the movable span may be easily provided by adding or taking off concrete or cast iron blocks in properly located pockets. Blocks weighing not over 100 pounds (45kg) each shall be used. They shall be provided with eye or ring bolts to facilitate handling. Space for 5 percent under and over the calculated weight (mass) shall be provided. Movable blocks shall be provided as specified. Pockets shall be provided with drain holes at least 6 inches (150 mm) in diameter. If counterweights of bascule and vertical lift bridges are located above the floor of approaches, the vertical clearance between

809.37

counterweights and the floor, curbs, sidewalks or handrails shall not be less than 2 1/2 feet (750 mm) when the bridge is fully open including any over travel. In calculating the minimum clearance, counterweight ropes shall be assumed to stretch 2 percent of their calculated length.

Concrete for counterweight and adjusting blocks shall be Class A, complying with Section 901 weighing approximately 145 pounds per cubic foot (2300kg/cu m). Steel punchings or bulk metal may be used. To increase the relative unit weight (mass) of the counterweight concrete to a maximum of 315 pounds/cubic foot (5000kg/cu m). Such a mixture shall not be used, unless retained in place by surrounding steel box or by walls of reinforced concrete.

The structural steel fabricator shall determine the weight (mass) and when it is necessary, location of the center of gravity of the moving span, including all parts attached thereto, and of the counterweights, including their frames. These determinations shall be based on weights (mass) computed from approved shop plans and shall include structural steel, machinery, flooring and everything attached to movable parts of the bridge. The adjustment pocket of counterweights is to be assumed 1/2 full when determining the size of counterweights. The contractor shall submit to the Bridge Design Engineer for approval, calculations for determining the weight (mass) of concrete for counterweights.

Determination of the proper mixture for counterweights to give the desired unit weight (mass) is especially important. A series of tests shall be made well in advance of the time that placing of concrete is to begin to determine the unit weight of concrete which can be obtained from the materials at hand. Test blocks containing at least 1 cubic foot (0.03 cu m) shall be made and a record kept showing the weight (mass) of the blocks when cast and when 1, 2, 3 and 7 days old and continuing until the weight stabilizes. The engineer shall be notified at least 3 days prior to casting of test blocks. The casting and weighing of blocks shall be done in the presence of the engineer. This record of test blocks shall be submitted for the engineer's approval before concreting is to begin. These tests shall be made by the contractor in time to have the information available for the fabricator by the time the latter is ready to detail counterweights.

The contractor shall furnish the engineer and fabricator with the unit weight (mass) of materials used in the deck. The determination of unit weights (mass) shall be made by actually weighing samples of these materials. If the floor is concrete, test blocks shall be made as outlined above to determine the unit weight (mass) of the deck slab as constructed.

The contractor shall be responsible for the correctness of the center of gravity calculations and for the detailed drawings of counterweights and construction of counterweights of correct unit weight (mass) so that the completed bridge will be in proper balance. The contractor shall be responsible for the balancing of the bridge and shall make necessary adjustments and alterations required to obtain proper balance.

809.39 POWER PLANT. The power plant shall comply with the requirements for Electrical Systems in Section 730.

809.40 OPERATING AND MACHINERY HOUSES. The operating house and machinery house shall be constructed in accordance with the plans. Necessary parts of fittings not shown or specified shall be furnished by the contractor at no direct pay.

809.41 MEASUREMENT.

(a) Movable Bridge Machinery: Movable bridge machinery will be measured on a lump sum basis, which includes all gears (including gears for operating limit switches), shafts, couplings, bearings, castings, wedges, wedge bases, latches, speed reducers, lubricating system, center pivots, racks and tracks for swing spans, bearing discs, balance wheels, trunnions and trunnion bearings, pins, sleeves, sheaves, wire ropes and their sockets and socket pins, bolts, screws, bolts and nuts connecting machinery parts to structural steel, castings which form an integral part of machinery, winding drums, tread plates and castings for segmental girders and track girders for rolling lift spans and their connecting bolts, pistons and cylinders, eccentrics, pinions, ring gears, racks, clutches, brakes other than electrical brakes, rollers, valves, locks, toggles, crank arms, cranks, axles, hooks, bearing liners, wrenches, springs, manually operated roadway traffic gates, mechanically operated position indicators and all other parts and fittings necessary for the satisfactory operation of the bridge which require machine shop work and which are not included in any other class, and all items classified as "Movable Bridge Machinery" on the plans.

(b)Traffic Barriers: Traffic barriers will be measured on a lump sum basis, which includes furnishing all materials and erecting the traffic barriers.

(c) Power Plant: The power plant will be measured on a lump sum basis in accordance with Electrical Systems in Section 730.

(d)Operating House: The operating house will be measured for payment on a lump sum basis, which includes all obviously necessary parts of

809.37

the house, including furniture and cabinets. If the house is supported on piling, the piling will be measured as provided in Section 804.

(e) Machinery Houses: Machinery houses will be measured for payment on a lump sum basis, which includes all obviously necessary parts of the houses.

(f) Counterweights: Class A concrete in counterweights will be measured by the cubic yard (cu m) in accordance with Subsection 805.17.

Deformed reinforcing steel or structural steel used in counterweights will be measured as provided in Subsections 806.09 and 807.53.

809.42 PAYMENT. Payment for machinery, traffic barriers, operating house and machinery houses will be made at the lump sum contract prices.

Payment for concrete, reinforcing steel or structural steel used in counterweights will be made as provided in Subsections 805.18, 806.10 and 807.54. Payment for power plant will be made as provided for Electrical System in Subsection 730.09.

Payment will be made under:

Item No.	Pay Item	Pay Unit
809-01	Movable Bridge Machinery	Lump Sum
809-02	Traffic Barriers	Lump Sum
809-03	Operating House	Lump Sum
809-04	Machinery Houses	Lump Sum

Section 810

Bridge Railings and Barriers

810.01 DESCRIPTION. This work consists of furnishing and constructing bridge railings and barriers.

810.02 MATERIALS. Materials shall comply with Section 1012.

810.03 CONSTRUCTION, FABRICATION, ERECTION AND PAINTING. All construction, fabrication, erection and painting shall conform to Sections 805, 806, 807 and 811 as modified herein.

After completing the deck pour, a minimum of 3 days shall elapse or concrete in the deck slab shall attain a minimum compressive strength of 1,600 psi (11 MPa) before placing of reinforcing steel and forms for concrete railings. The deck slab shall attain a minimum compressive strength of 3,500 psi (24.1 MPa) before pouring concrete railings. Compressive strength cylinders shall be made in accordance with DOTD TR 226 and tested in accordance with DOTD TR 230. The use of curing compounds will not be permitted on concrete railings.

Slip-formed concrete will be permitted, subject to the following provisions. Sliding forms shall be rigidly held together to prevent spreading of forms, and after passing there shall be no noticeable slumping of concrete. Concrete shall be held at a uniform consistency, having a slump of 1/2 inch to 1 1/2 inches (13 mm to 40 mm). The contractor's proposed slip-form procedures and equipment shall be approved prior to beginning slip-form concrete placement, and the contractor will be required to make a dry run with the paving machine prior to placement. If the contractor elects to saw the intermediate open joints in the railing, the joint width may be reduced from 1/2 inch (13 mm) to 1/4 inch (6 mm). Joint widths at expansion joints shall match plan dimensions. Joint sawing shall begin as soon as the concrete has reached strength such that tearing and raveling of the concrete does not occur. If, in the opinion of the engineer, the slip-form operation fails to produce satisfactory results, the contractor shall immediately discontinue slip-form operations, shall replace or satisfactorily repair the unacceptable concrete, and shall complete the work using conventional forming methods.

810.04

810.04 LINE AND GRADE. Line and grade of the top of the railing or barrier shall be true to that shown on the plans and shall not follow any unevenness in the superstructure. Barrier, railing and curbs shall be normal to roadway cross slope and grade.

810.05 EXPANSION JOINTS. Expansion joints shall be so constructed as to permit freedom of movement. After the work is completed, loose or thin mortar likely to spall under movement shall be removed.

810.06 PLACING RAILING. Concrete barrier or railing shall not be placed until falsework for the span has been released, and the span is self-supporting. On continuous spans, railing or barriers shall not be placed until the deck of the continuous unit is completed.

810.07 METAL RAILING. Metal railing shall be adjusted prior to its being fixed in place to ensure proper matching at abutting joints and correct alignment and camber throughout its length. Holes for field connections shall be drilled with the railing in place on the structure at proper grade and alignment.

810.08 MEASUREMENT. Quantities of railings and barriers for payment will be the design lengths as specified on the plans and adjustments thereto. Design quantities for railing include all work constructed above the roadway curb, sidewalk or sidewalk curb. Design quantities of barriers include all work constructed above the roadway. Design quantities will be adjusted if the engineer makes change to adjust to field conditions, if plan errors are proven, or if design changes are made.

Reinforcing steel and hardware for railings and barriers will not be measured for payment.

810.09 PAYMENT. Payment for railing and barriers will be made at the contract unit price per linear foot (lin m), subject to the following provisions.

Payment for concrete railing will be made on a lot basis. A lot will be a completed unit or an identifiable pour that is completed in one day.

Payment for each lot will be subject to adjustments in accordance with Table 901-5 and Note 1.

Payment will be made under:

Item No.	Pay Item	Pay Unit
810-01	Concrete Railing (Type)	Linear Foot (Lin m)
810-02	Steel Railing	Linear Foot (Lin m)
810-03	Pipe Railing	Linear Foot (Lin m)
810-04	Steel and Concrete Railing	Linear Foot (Lin m)
810-05	Pipe and Concrete Railing	Linear Foot (Lin m)

Section 811

Painting and Protective Coatings

811.01 DESCRIPTION. This work consists of furnishing and applying paints and other protective coatings, including preparation of surfaces.

Unless otherwise specified, an approved Zinc Paint System shall be used for coating metal surfaces requiring painting.

The QPL paint system to be used must be shown on shop or working drawings.

Metal surfaces to be painted shall be cleaned in accordance with the Near-White Blast Cleaning Method described in Subsection 811.06(b).

811.02 SAFETY STANDARDS. The contractor shall comply with Federal, State and local laws, rules and regulations concerning construction safety and health standards and all requirements of Section 107. Appropriate respiratory protective devices shall be provided by the contractor and shall be used. Respiratory equipment, including hood type respirator with external air supply to hood, shall meet the approval of the U.S. Bureau of Mines.

811.03 MATERIALS. All paints shall be in accordance with the requirements of Section 1008.

(a) Three-Coat Waterborne Paint System (two primers and one topcoat): The Three-Coat Waterborne Paint System shall comply with Subsection 1008.02. The contractor has the option of using any system on the QPL; however, no modification or combining of systems will be permitted and the same system shall be used throughout the project.

(b) The Coal Tar Epoxy-Polyamide Paint System shall comply with Subsection 1008.04.

(c) Cold galvanizing repair compound shall comply with Subsection 1008.05.

(d) Corrosion Inhibiting Alkyd Paint shall comply with Subsection 1008.06.

(e) Zinc Paint Systems for New Steel and 100 Percent Bare Existing Steel: The zinc paint system shall be an approved system listed on QPL 78. Each system shall be tested in accordance with AASHTO R 31 and meet the requirements of Subsection 1008.07. The contractor has the option of

using any one of these systems; however, no modifications or combinations of the systems will be permitted and the same system shall be used throughout the project.

811.04 PAINTING METAL. All metal surfaces shall be painted unless painting would interfere with proper operation of movable metal parts.

When field welded connections are required, areas to be welded shall be masked before shop painting of members and painted after welding.

Control desks and switchboards shall be painted as described on the plans. Equipment mounted on control desks and switchboards shall not be painted.

When required, galvanized or metallized surfaces of sheet metal, electrical conduit, and water, air and gas pipes that are exposed and visible shall be painted. Other galvanized or metallized surfaces shall not be painted unless otherwise specified.

Metal surfaces to be encased in concrete shall be painted with a minimum of one prime coat. Painting of aluminum surfaces will not be required.

(a) Three-Coat Waterborne Paint System: The minimum dry film thickness of coatings shall be as follows:

1st Prime Coat	3.0 mils (75 μm)
2nd Prime Coat	3.0 mils (75 μm)
Topcoat	3.0 mils (75 μm)

Color contrast in the two prime coats shall be provided by the differences in the wet coating and the dried coating.

(b) Coal Tar Epoxy-Polyamide System: The minimum dry film thickness of coatings shall be as follows:

1st Coat	8.0 mils (200 μm)
Final Coat	8.0 mils (200 μm)

(c) Corrosion Inhibiting Alkyd Paint System: Corrosion Inhibiting Alkyd Paint shall be a non-polluting pigmented alkyd paint to be used in a three-coat paint system on properly prepared structural steel surfaces to be permanently exposed. The contractor has the option of using either System A or System B, however, whichever system is selected shall be used on the entire project. The primer and intermediate coats shall be tinted for color contrast.

811.04

The minimum dry film thickness of the coatings shall be as follows:

Prime Coat	- 2.0 mils (50 μm)
Intermediate Coat	- 2.0 mils (50 μm)
Aluminum Topcoat	- 2.0 mils (50 μm) - AASHTO M69, Type I

(d) Zinc Paint Systems for New Steel and 100 Percent Bare Existing Steel: The specified dry film thickness of coatings shall be as published in QPL 78.

811.05 WEATHER LIMITATIONS. Paint shall be applied on thoroughly dry surfaces and during periods of favorable weather with the relative humidity being below 85 percent. Painting will not be permitted when any of the following conditions occur: the surface temperature is less than 5°F (3°C) above the dew point, the wind velocity is 15 mph (25 km/h) or higher, or the ambient air temperature is below 50°F (10°C) in the shade and away from artificial heat except as provided in this subsection for enclosures. Paint also shall not be applied unless the surface temperature of the metal is at least 45°F (7°C) and rising, and shall not exceed manufacturer's recommendations or be hot enough to cause the paint to blister and produce a porous paint film, whichever is less.

When fresh paint is damaged by the elements, it shall be replaced by the contractor at no direct pay.

Subject to approval in writing, the contractor may provide and maintain suitable enclosures to permit painting during inclement weather at no direct pay. Provisions shall be made to control atmospheric conditions inside the enclosure within limits suitable for painting throughout the painting operation.

When painting operations inside an enclosure result in a humidity increase above 85 percent, airflow through the enclosure shall be suitable to maintain the relative humidity to below 85 percent throughout the painting operations.

811.06 CLEANING OF SURFACES.

(a) General: Metal surfaces to be painted shall be abrasive blast cleaned in accordance with Heading (b) and shall produce an anchor pattern from 1 to 3 mils (25 to 75 μm).

Surfaces that are to be galvanized may be either chemically cleaned by emersion (sequence of caustic cleaning, water rinse, acid pickling and water rinse) or a combination of blast and chemical cleaning.

When steel abrasive blasting is used, the abrasive mixture shall have a minimum of 25 percent by volume of approved grit material. Grit size shall be SAE G-25 with a minimum hardness of 45, Rockwell "C" Range.

Surfaces of a casting shall be blast cleaned before the casting is machined.

Weld spatter and other undesirable materials shall be removed and sharp edges ground smooth prior to blast cleaning. All abrasive blasting equipment shall be equipped with an oil/moisture trap with replaceable cartridges (filters) located between the air supply and the pressure pot.

(b) Near-White Blast Cleaning Method: This method prepares metal surfaces for painting or coating by the use of abrasives propelled through nozzles or by centrifugal wheels.

(1) Definition: The near-white cleaned surface is defined as one from which all oil, grease, dirt, mill scale, rust, corrosion products, oxides, paint or other foreign matter have been completely removed except for very light shadows, very slight streaks or slight discolorations caused by rust stain, mill scale oxides or slight and tight residues of paint or coating. At least 95 percent of each square inch (1000 sq mm) of surface area shall be free of visible residues and the remainder shall be limited to the light discoloration mentioned above.

(2) Procedures: Near-White Cleaning shall be in accordance with SSPC-SP 10 with the following modifications. Rate of blast cleaning may vary from one area to the next to achieve the desired pattern. The use of recycled steel abrasive blasting materials will be permissible, provided anchor pattern requirements are met and adhesion is not compromised. Blast cleaned surfaces shall be painted before rusting occurs, preferably within 8 hours after blasting. Blast cleaned surfaces shall be painted the same day or reblasted. Occurrence of rusting after cleaning shall be cause for recleaning by blasting or other cleaning methods as directed.

(3) Safety Precautions: Safety precautions shall be in accordance with SSPC-SP 10.

(c) Commercial Blast Cleaning Method: This method prepares metal surfaces for painting by the use of abrasives propelled through nozzles or propelled by centrifugal wheels.

(1) Definition: The commercial blast cleaned surface is defined as one from which all oil, grease, dirt, rust scale and foreign matter have been completely removed from the surface and all rust, mill scale and old paint have been completely removed except for slight shadows, streaks or discolorations caused by rust stain, mill scale oxides or slight, tight residues of

811.04

paint or coating that may remain; if the surface is pitted, slight residues of rust or paint may be found in the bottom of pits; at least 2/3 of each square inch (1000 sq mm) of surface area shall be free of visible residues and the remainder shall be limited to the light discoloration, slight staining or tight residues mentioned above.

(2) Procedures: Procedures for Commercial Blast Cleaning shall be in accordance with SSPC-SP 6. Blast cleaned surfaces shall be painted before rusting occurs. Blast cleaned surfaces shall be painted the same day or be reblasted.

(3) Safety Precautions: Safety precautions shall be in accordance with SSPC-SP 6.

(d) Compressed Air Cleaning: Prior to the application of paint, blast cleaned surfaces shall be cleaned of excess abrasive using compressed air that has been filtered by an approved oil/moisture trap.

811.07 PROTECTION OF THE PUBLIC AND WORK. The contractor shall protect the public and all parts of the work against disfigurement by spatters, splashes and smirches of paint materials and damage caused by surface preparation. The contractor shall be responsible for damage caused by the contractor's operations to vehicles, persons or property, including plants and animals. The contractor shall provide protective measures to prevent such damage.

Paint stains which result in an unsightly appearance shall be removed or obliterated by the contractor at no direct pay.

When traffic causes an objectionable amount of dust, the contractor shall alleviate the dust for the necessary distance on each side of the work and take other precautions necessary to prevent dust and dirt from coming in contact with freshly painted surfaces or with surfaces before paint is applied.

811.08 APPLICATION. Primers and top coat shall be applied at the specified minimum film thickness. Where members are found low in film thickness for either primer or top coat, the entire member shall be recoated. The contractor shall exercise the necessary controls to eliminate laps, sags, over spray patterns and other undesirable characteristics.

Measurement of dry film thickness shall be made in accordance with SSPC-PA 2.

(a) Three-Coat Waterborne Paint System: Primer and topcoat paint shall be applied with airless or conventional spray equipment. The spray

equipment shall apply paint in a fine, even spray. If thinning of paint is allowed, it shall be done in accordance with the paint manufacturer's recommendations but in no case shall exceed 10 percent. An approved oil/moisture trap shall be placed between air supply and pressure pot, and regulators and gages shall be provided for both air supply and pressure pot. Fluid pressure shall be regulated to deliver a uniform and wet coat of material from the spray gun.

On surfaces inaccessible to spray equipment, paint shall be applied with brush or approved daubers to ensure coverage.

(1) Primer: Primer for new steel shall be applied after fabrication and the two prime coats shall be applied at the shop.

Each primer coat shall be cured at least 24 hours before the next coat of primer or topcoat is applied. The curing times shall be the cumulative time that the ambient air temperature is 50°F (10°C) or above.

Before application of subsequent coats of paint, all surfaces shall be cleaned of any dirt, dry spray, overspray, or other residue. A 72 hour curing time will be required for steel painted at the shop before it can be handled for shipment.

(2) Field Spot Painting: Damaged areas or other surfaces to be field primed or painted shall be blast cleaned in accordance with Subsection 811.06(b) or power tool cleaned to bare metal in accordance with SSPC SP11 and painted with the approved primer and/or topcoat to a minimum dry film thickness of 6.0 mils (150 µm) for primer and 3.0 mils (75 µm) for topcoat. Primer shall be allowed to cure 24 hours prior to application of topcoat.

(3) Topcoat: Unless otherwise specified, topcoat paint for new steel shall be applied after field erection, field spot painting and cleaning of primer surfacing.

Dust film, dry spray, overspray or other residue shall be removed prior to painting. The use of sand paper for cleaning is acceptable, provided the minimum dry film thickness of primer remains.

(b) Coal Tar Epoxy-Polyamide System: Coal tar epoxy-polyamide paint shall be applied in accordance with the paint manufacturer's recommendations. Recoat time shall be in accordance with manufacturer's recommendations, but in all cases, the application of the second coat shall be within 24 hours unless cold temperatures have affected the cure of the first coat.

(c) Zinc Paint Systems for New Steel and 100 Percent Bare Existing Steel: Each coat of paint shall be applied with airless or conventional spray equipment. The spray equipment shall apply paint in a

811.04

fine, even spray. If thinning of paint is allowed, it shall be done in accordance with the paint manufacturer's recommendations, but in no case shall exceed 10 percent. An approved oil/moisture trap shall be placed between air supply and

pressure pot. Fluid pressure shall be regulated to deliver a uniform and wet coat of material from the spray gun.

On surfaces inaccessible to spray equipment, paint shall be applied with brush or approved daubers to ensure coverage.

(1) Primer (Shop Primer): Primer for new steel shall be applied after fabrication with one coat of the inorganic zinc paint applied at the shop. The dry-to-handle curing time shall be based on the temperature and relative humidity requirements of the manufacturer's product data sheet curing schedule. A 72 hour curing time will be required for steel painted at the shop before it can be shipped.

(2) Field Painting: Primer for existing steel and damaged areas of newly erected steel with a shop primer coat of inorganic zinc paint shall be applied after the steel is blast cleaned in accordance with Subsection 811.06(b) or power tool cleaned to bare metal in accordance with SSPC SP11 with an approved organic zinc paint system listed on QPL 78. Each coat of paint shall be applied in accordance with the dry film thickness requirements listed on QPL 78 and allowed to cure in accordance with temperature and relative humidity requirements of the manufacturer's product data sheet curing schedule.

(3) Intermediate Coat and Topcoat: Unless otherwise specified, intermediate coat and topcoat paint for new steel shall be applied after field erection, field spot painting and cleaning of primer surfacing. Dust film, dry spray, overspray or other residue shall be removed prior to painting. The use of sand paper for cleaning is acceptable, provided the minimum dry film thickness of primer remains.

811.09 SHOP PAINTING.

(a) Surfaces to be Painted: When fabrication and cleaning are completed, surfaces not painted during assembly shall be painted with one coat of the specified paint before damage occurs to the cleaned surface from weather or other exposure. Shop and field contact surfaces shall be prepared as specified in Subsection 807.21(e). Where paint would be detrimental to field welding operations, the surface shall not be shop painted within a suitable distance from edges to be welded or spliced.

(b)Erection Marks: Erection marks shall be painted on surfaces with a compatible paint of contrasting color.

(c) Loading: Material shall not be loaded for shipment until paint is dry and cured in accordance with Subsection 811.08(a)(1).

(d)Inaccessible Surfaces: Surfaces not to be in contact, but which will be inaccessible after assembly or erection, shall receive the complete paint system prior to assembly or erection.

(e) Machine Finished Surfaces: With the exception of abutting chord and column splices, rocker shoes and bases, and column and truss shoe bases, machine finished surfaces shall be coated with an approved protective coating as soon as practical after being accepted and before removal from the shop. Surfaces of iron and steel castings which are machine finished for the purpose of removing scales, fins, blisters or other surface deformations shall be painted with the specified paint system.

(f) Pins and Pin Holes: Pins and pin holes shall be given a coat of an approved protective coating. The protective coating shall be removed and replaced with a graphite coating prior to erection.

811.10 FIELD PAINTING. As soon as surfaces have been cleaned to the satisfaction of the engineer, heads of field rivets and bolts and any surfaces from which the shop coats of paint have been worn off or have otherwise become defective shall be covered with two coats of the same paint used in the shop in accordance with Subsection 811.08(a)(1). When the paint applied for touching up rivet or bolt heads and abraded surfaces has dried, the field coat may be applied. No coat shall be applied until the previous coat has dried throughout the full thickness of paint film.

The field coat of paint shall not be applied to the steel work below the highway floor level until the concrete roadway slab and concrete barrier railings have been completed and metalwork cleaned. If concreting operations have damaged the paint, the surface shall be cleaned and spot primed as directed.

During pouring of decks and concrete barrier railings, the contractor shall keep steel members clean by washing and shall remove any materials that adhere to the surface and mar the finish of the steel members.

When weathering steel is used for structural members such as bridge girders, the ends of the members shall be painted for a distance of 1.5 times the member depth. The paint color shall match the oxidized color of the weathered steel after two years of weathering. Brown pigment, federal color

811.04

#30045, shall be added to the topcoat of the paint system being applied to the ends of the member.

811.11 PAINTING LUMBER AND TIMBER. Lumber and timber requiring painting shall be satisfactorily cleaned and painted with three coats of the specified paint. If not specified, the paint to be used will be selected by the engineer. Treated timber to be painted shall be processed in accordance with Subsection 1014.04(c).

All applicable requirements of this section shall apply to the painting of lumber and timber.

811.12 GALVANIZING. The following criteria shall be properly controlled and shall meet standards that are satisfactory for the galvanizing process.

1. Defects arising from fabrication
2. Thickness and uniformity of coating
3. Adherence of coating
4. Appearance
5. Embrittlement

Handling, stacking, transporting and erecting galvanized parts shall be done in such manner as to protect the coating and its appearance.

Galvanized parts shall be assembled with nonabrasive equipment.

Drip holes shall be satisfactorily plugged.

Galvanizing of products fabricated from rolled, pressed and forged steel shapes, plates, bars and strips, 1/8 inch (3 mm) thick and heavier, shall comply with ASTM A 123. Galvanizing shall be performed after fabrication into the largest practical sections. Fabrication shall include all operations such as shearing, cutting, punching, forming, drilling, milling, bending, welding and riveting. Components of bolted assemblies shall be galvanized separately before assembly. When it is necessary to straighten sections after galvanizing, such work shall be performed without damage to the zinc coating.

Galvanizing of iron and steel hardware shall comply with ASTM A 123 and A 153 or shall be accomplished by an approved mechanical galvanizing method complying with ASTM B 695 that provides the same thickness of coating. Galvanizing shall be performed after fabrication of hardware.

Components of bolted assemblies shall be galvanized separately before assembly.

Galvanized surfaces that are abraded or damaged after application of the zinc coating shall be repaired by thoroughly wire brushing the damaged areas and removing loose and cracked coating, after which the cleaned areas shall be repaired by application of an approved cold galvanizing repair compound. Zinc coating by the metallizing process may be allowed when approved.

The galvanizer shall utilize all of the options available to prevent "white rust" from occurring. However, should "white rust" occur and in the opinion of the engineer it is excessive or unsightly it shall be cause for rejection. Should rejection of the product occur, the galvanizer or contractor shall have prior approval before taking any corrective action.

811.13 METALLIZING OF METAL PARTS AND SURFACES. When specified, metallizing shall be performed in accordance with AWS C 2.2 and thickness of the sprayed zinc coat shall be a minimum of 5 mils (125 μm). The method of applying the zinc coating shall be approved prior to application.

811.14 MEASUREMENT AND PAYMENT. No measurement or payment will be made for painting or any protective coating.

Section 812 Treated Timber

812.01 DESCRIPTION. This work consists of furnishing lumber of the sizes and grade specified and of furnishing timber of the stress-grade, sizes and dimensions for the different uses specified, treated, and of preparing, framing, assembling and erecting the same, including painting where specified, and all hardware. Unless otherwise specified, all timber shall be treated.

812.02 MATERIALS. Materials shall comply with the following Subsections:

Castings	1013.05(a),
	1013.06(a)
Structural Timber and Lumber	1014.01
Preservatives	1014.03
Treatment	1014.04
Connectors	1018.07
Hardware and Structural Shapes	1018.08
Roofing Pitch	1018.13

812.03 SPECIES OF WOOD.

(a) Permanent Structures: Timber and lumber used in permanent bridges, bridge fenders and bulkheads may be either Douglas Fir or Southern Yellow Pine, provided the same species is used throughout each structure, except in bridge structures as hereinafter provided.

Caps and stringers for bridges may be either fir or pine; however, all caps and stringers furnished for any structure shall be the same species.

(b) Temporary Structures: Temporary bridges shall conform to Section 725. All other temporary structures may be any satisfactory species and grade of timber.

812.04 STORAGE OF MATERIAL. Lumber and timber stored on the site shall be kept in orderly stacks. Material shall be openstacked on supports above ground, and shall be so stacked and stripped as to permit free circulation of air between tiers and courses. When directed, protection from the weather by suitable covering will be required.

812.05 TIMBER.

(a) Workmanship: Nails and spikes shall be driven with just sufficient force to set the heads flush with the surface of the wood. Deep hammer marks in wood surfaces shall be considered evidence of poor workmanship and sufficient cause for removal of the workman causing them.

(b) Surfacing: Lumber and timber, except bulkhead planks and sway bracing, shall be S4S.

(c) Handling: Treated timber shall be handled with rope slings, without dropping or breaking of outer fibers, bruising, or penetrating the surface with tools.

(d) Framing and Boring: Cutting, framing and boring of treated timber shall be done before treatment insofar as practical. When treated timber is to be placed in water infested by marine borers, untreated cuts, borings or other joint framings below highwater elevation shall be avoided.

(e) Installation of Timber Connectors: The split ring and the shear plate shall be installed in precut grooves of dimensions as specified or as recommended by the manufacturer. The toothed ring and the spike grid shall be forced into contact surfaces of the timbers joined by means of pressure equipment. Connectors of this type at a joint shall be embedded simultaneously and uniformly. Fabrication of structures using connectors shall be done prior to treatment.

Timber, after fabrication, shall be stored in a manner, which will prevent changes in dimensions of members before assembly.

Dimensions of materials and details not specified shall be subject to approval.

(f) Cuts and Abrasions: Cuts and abrasions in creosoted piles or timbers, after having been carefully trimmed, shall be covered with two applications of creosote complying with Subsection 1014.03(e) and covered with hot roofing pitch.

Cuts and abrasions in timber treated with other preservatives shall be repaired with the same preservative.

(g) Bolt Holes: Holes bored in pressure-treated material shall be filled with preservative. Unused bore holes and spike holes shall be poured full of preservatives and plugged with tight-fitting treated plugs.

(h) Temporary Attachment: When, with the approval of the engineer, forms or temporary braces are attached to treated timber with nails or spikes, holes shall be filled by driving galvanized nails or spikes flush with the surface or plugged as required for bolt holes.

812.06 TREATMENT OF PILE HEADS.

(a) General: After cutting, pile heads shall be treated to prevent decay. Pile heads to be encased in concrete will not require treatment.

Immediately after making final cut-off on treated timber foundation piles, the cut area shall be given two liberal applications of preservative followed by a heavy application of hot roofing pitch or other approved sealer. Heads of treated timber piles in bents or where the cut-off is exposed shall be protected by one of the following methods, as specified. If not specified, galvanized metal coverings shall be used.

(b) Galvanized Metal Coverings: The sawed surface shall be thoroughly brush coated with two applications of creosote oil, after which there shall be placed two layers of heavy canvas size 20 by 20 inches (500 mm by 500 mm) saturated with hot roofing pitch, followed by a 24 by 24 inches, 28 gage (600 mm by 600 mm, 0.5 mm thick) galvanized metal cover. The cover shall be bent down over the pile approximately 45 degrees.

(c) Fabric Covering: Heads of treated piles shall be covered with alternate layers of hot pitch and loosely woven fabric complying with ASTM D 173, using four applications of pitch and three layers of fabric. The cover shall measure at least 6 inches (150 mm) more in dimension than the diameter of the pile and shall be neatly folded down over the pile and secured by large headed galvanized nails or by binding with at least seven complete turns of galvanized wire securely held in place by large-headed galvanized nails and staples. Edges of fabric projecting below the wire wrapping shall be trimmed to present a workmanlike appearance.

812.07 HOLES FOR BOLTS, DOWELS, RODS AND LAG SCREWS.

Holes for drift bolts and dowels shall be bored perpendicular to the face of the timber and shall be 1/16 inch (2 mm) less in diameter than bolt or dowel. For square drift bolts or dowels, the diameter of the bored hole shall be equal to the least dimension of the bolt or dowel.

Holes for machine bolts shall be bored the same diameter as the bolt.

Holes for rods shall be bored 1/16 inch (2 mm) greater in diameter than the rod.

Holes for lag screws shall be bored not larger than the body of the screw at the base of the thread.

812.08 BOLTS AND WASHERS. A washer of the size and type specified shall be used under bolt heads and nuts which would otherwise come in

contact with wood. Stacked washers will not be permitted. Bolts shall not project

more than 1 inch (25 mm) beyond the nut on work securely tightened. Long bolts shall be saw-cut or clipped, ground smooth and repaired as specified in Subsection 811.12.

Nuts of bolts shall be locked after they have been tightened.

812.09 COUNTERSINKING. Countersinking shall be done when smooth faces are required. Horizontal recesses formed for countersinking shall be painted with creosote complying with Subsection 1014.03(e) and, after bolt or screw is in place, filled with hot roofing pitch.

812.10 FRAMING. Lumber and timber shall be accurately cut and framed to a close fit in such manner that joints will have even bearing over the contact surfaces. No shimming will be permitted in making joints nor will open joints be accepted. Mating pieces shall be tightly bound or clamped in position prior to drilling bolt holes.

812.11 PILE BENTS. Piles shall be driven in accordance with Section 804.

812.12 CAPS. Timber caps shall be placed, with ends aligned, in a manner to secure uniform bearing over tops of supporting posts or piles. Caps shall be secured by drift-bolts of at least 3/4 inch (20 mm) diameter extending at least 9 inches (230 mm) into posts or piles. Drift-bolts shall be approximately in center of the post or pile.

812.13 BRACING. Ends of bracing shall be bolted through pile, post or cap with a bolt of at least 5/8 inch (16 mm) diameter. Intermediate intersections shall be bolted or spiked with wire or boat spikes. Spikes shall be used in addition to bolts.

812.14 STRINGERS. Stringers shall be sized at bearings and placed in position so that knots near edges will be in top portions of stringers.

Outside stringers may have butt joints with ends cut on a taper, but interior stringers shall be lapped to take bearing over the full width of floor beam or cap at each end. When stringers are two panels in length, joints shall be staggered.

812.06

Cross-bridging between stringers shall be neatly and accurately framed and securely toe-nailed with at least two nails in each end. Cross-bridging members shall have full bearing at each end against sides of stringers. Cross-bridging shall be placed at the center of each span.

812.15 PLANK FLOORS. Single plank floors shall consist of a single thickness of plank supported by stringers or joists. Planks shall be laid heart side down, with 1/4 inch (6 mm) openings between them for seasoned material and with tight joints for unseasoned material. Each plank shall be securely spiked to each joist. Planks shall be graded as to thickness and so laid that no two adjacent planks vary in thickness by more than 1/16 inch (2 mm).

Two-ply timber floors shall consist of two layers of flooring supported on stringers or joists. The lower course shall be pressure-treated with creosote oil. The top course may be laid either diagonal or parallel to the centerline of roadway, as specified, and each floor piece shall be securely fastened to the lower course. Joints shall be staggered at least 3 feet (1 m). If the top course is placed parallel to the roadway centerline, care shall be taken to securely fasten ends of flooring. At each end of the bridge, these members shall be beveled.

812.16 LAMINATED OR STRIP FLOORS. Strips shall be placed on edge at right angles to the roadway centerline. Each strip shall be spiked to the preceding strip at each end and at approximately 18-inch (450 mm) intervals, with the spikes driven alternately near the top and bottom edges. Spikes shall be of sufficient length to pass through two strips and at least halfway through the third strip.

If timber supports are used, every other strip shall be toe-nailed to every other support. When specified, strips shall be securely attached to steel supports with approved galvanized metal clips. Care shall be taken to have each strip vertical and tight against the preceding one and bearing evenly on supports.

812.17 WHEEL GUARDS AND RAILING. Wheel guards and railing shall be framed in accordance with the plans and erected true to line and grade. Wheel guards shall be laid in sections at least 12 feet (3.6 m) long.

812.18 PAINTING AND PROTECTIVE COVERINGS. Parts of structures to be painted will be as specified. Metal parts not galvanized shall be painted in accordance with Section 811.

When timber decks are provided, top flanges of stringers and floor beams shall be protected by a covering composed of a heavy layer of hot roofing pitch and one thickness of 2-ply tar paper wide enough to project 3 inches (75 mm) beyond edges of members. These edges shall be bent down approximately 45 degrees.

812.19 MEASUREMENT. Quantities of timber for payment will be the design quantities and adjustments thereto. The design quantities are based on the number of thousand board feet (cu m) of timber in the completed work. Design quantities will be adjusted if the engineer makes changes to adjust to field conditions, if plan errors are proven, or if design changes are necessary. Hardware will not be measured for payment. Metal parts not classified on the plans as hardware will be measured and paid for in accordance with Section 807.

812.20 PAYMENT. Payment for timber will be made at the contract unit price per thousand board feet (cu m).

Payment will be made under:

Item No.	Pay Item	Pay Unit
812-01	Treated Timber	MFBM (Cu m)

Section 813 Concrete Approach Slabs

813.01 DESCRIPTION. This work consists of furnishing and constructing concrete approach slabs for bridges and other structures in accordance with the details, locations and dimensions shown on the plans.

813.02 MATERIALS. Materials shall comply with the following Sections and Subsections:

Portland Cement Concrete	901
Bedding Material	1003.08
Joint Materials	1005
Plastic Underdrain Pipe	1006.08
Deformed Reinforcing Steel	1009.01
Polyethylene Film	1011.01(d)
Timber Piling	1014
Hardware Cloth	1018.21
Geotextile Fabric	1019.01

Bedding material shall be either stone, or recycled portland cement concrete in accordance with Subsection 1003.08(a).

Geotextile fabric shall comply with Section 1019, Classes B, C, or D. The fabric shall be resistant to chemical, biological and insect attack.

813.03 EMBANKMENT. The entire embankment affecting the construction of the abutment shall be constructed to grade in accordance with Section 203 before building the end bent or bridge abutment. A surcharge shall be constructed in areas where designated fill heights will result in settlement. The plans will indicate the amount of surcharge and length of time to remain in place. The surcharge will be removed prior to driving piles for end bent.

Geotextile fabric shall be placed as a separation layer between the embankment and the bedding material beneath the approach slab in accordance with Subsection 203.11. No equipment will be allowed on the fabric unless there is at least 6 inches (150 mm) of cover.

When specified, the approach slab subgrade shall be placed on a layer of bedding material in accordance with plan details. Bedding material shall be

placed and compacted as directed and covered with approved polyethylene film of at least 6-mil (150 μm) nominal thickness.

813.04 DRAINAGE SYSTEMS. Drainage systems shall be constructed in accordance with Section 703.

813.05 REINFORCING STEEL. Reinforcing steel shall comply with Section 806.

813.06 BEARING PILES. When shown in the plans, the approach slab shall be supported on bearing piles in accordance with Section 804.

813.07 CONCRETE. Concrete for all approach slabs shall be Class AA. Concrete for bolster blocks under approach slabs shall be either Class A, Class AA or one of the concrete pavement types. The slabs shall be constructed in accordance with Section 805.

Portland cement concrete headwalls for perforated pipe shall comply with Section 901, Class M concrete constructed in accordance with plan details.

Curing shall conform to Subsection 805.10. Surface tolerances shall conform to Subsection 805.13(d)(2).

813.08 ROADWAY FINISH. The roadway shall be given a metal tine texture finish. Surface finishing operations shall be performed in accordance with Subsection 805.13(d)(3). Approach slabs which require an asphaltic concrete overlay shall be finished in accordance with Subsection 805.13(d)(1) and a tine finish will not be used.

813.09 MEASUREMENT. Quantities of concrete approach slabs for payment will be the design areas as specified on the plans and adjustments thereto. Design quantities will be adjusted if the engineer makes changes to adjust to field conditions, if plan errors are proven, or if design changes are made. Design quantities are based on horizontal dimensions shown on the plans. Required reinforcing steel, bearing piles, joint materials, bedding materials, surcharge material, geotextile fabric, polyethylene film, plastic underdrain pipe, rodent screen, and headwalls, will not be measured for payment.

813.10

813.10 PAYMENT. Payment for concrete approach slabs will be made at the contract unit price per square yard (sq m) subject to the following provisions:

Acceptance and payment for concrete approach slabs will be made on a lot basis. A lot will be considered as a complete approach slab or an identifiable pour that is completed in one day. Two random batches will be sampled for each lot, and three cylinders molded for each batch. The six cylinders per lot will be tested for compressive strength in 28 to 31 days. In the event of sudden cessation of operations, a minimum of three cylinders will constitute a lot. Acceptance and payment for each lot will be made in accordance with Table 901-5 and Note 1.

Payment will be made under:

Item No.	Pay Item	Pay Unit
813-01	Concrete Approach Slabs	Square Yard (Sq m)
813-02	Concrete Approach Slabs (Pile Supported)	Square Yard (Sq m)

Section 814 Drilled Shaft Foundations

814.01 DESCRIPTION. This work consists of furnishing and constructing foundations of reinforced concrete shafts in drilled excavations in accordance with the plans and these specifications or as directed.

814.02 MATERIALS. Materials shall comply with the following Sections and Subsections. Concrete shall be Class S with water reducing and set retarding admixtures.

Portland Cement Concrete	901
Granular Material	1003.07
Reinforcing Steel	1009
Admixtures	1011.02

814.03 SUBMITTAL REQUIREMENTS. The contractor shall submit the drilled shaft contractor qualifications and the Drilled Shaft Installation plan for approval by the DOTD Chief Construction Engineer. The contractor's (drilled shaft contractor) qualifications shall meet or exceed the experience requirements described in Subsection 814.04. The proposed drilled shaft equipment and the drilled shaft installation method shall be such that drilled shafts shall be excavated through whatever materials are encountered, to the dimensions and elevations shown in the plans or otherwise required by the specifications and special provisions. In no case shall the drilling equipment be transported to the project site until approval is received in writing. Approval by the engineer of the contractor qualifications and installation plan will not relieve the contractor of responsibility to satisfactorily install shafts.

(a) Contractor Qualifications: The contractor shall submit the drilled shaft contractor's qualifications, as specified herein, prior to or in conjunction with, the Drilled Shaft Installation Plan submittal. Within 20 calendar days after receipt of the contractor's qualification submittal, the engineer shall approve or reject the drilled shaft contractor's qualifications. The contractor shall resubmit any changes in the drilled shaft contractor's qualifications for approval.

(b) Drilled Shaft Installation Plan: The contractor shall submit the Drilled Shaft Installation Plan no later than 30 calendar days prior to

814.03

commencing the drilled shaft construction. Within 20 calendar days after receipt of the drilled shaft installation plan the engineer will notify the contractor of any additional information required and/or changes that may be necessary to meet the plans, specifications and special provisions requirements. Any parts of the contractor's Drilled Shaft Installation Plan that are unacceptable shall be rejected and the contractor shall resubmit changes agreed upon for reevaluation. The engineer will notify the contractor within 10 calendar days after receipt of proposed changes to the Drilled Shaft Installation Plan of their acceptance or rejection. The contractor shall use the approved drilled shaft construction method during drilling operations. The contractor shall make any required changes that may result from unsatisfactory field performance. No changes in the drilling method may be made after final approval without the written approval of the DOTD Chief Construction Engineer.

814.04 EXPERIENCE REQUIREMENTS. The contractor shall have a minimum of three years experience in constructing drilled shaft foundations of similar size as required by the project within the past five years and shall submit descriptions of that experience. The descriptions of the drilled shaft projects shall contain names and telephone numbers of owners' representatives who can verify the contractor's participation on those projects.

The contractor's on-site drilled shaft superintendent(s) shall each have a minimum of two years experience in the construction of drilled shaft foundations and the drill operators shall have a minimum of one year experience. The contractor shall submit the name and experience records of the drill operator(s) and drilled shaft superintendent(s) in charge of the drilled shaft construction operations.

814.05 DRILLED SHAFT INSTALLATION PLAN. The engineer will evaluate the drilled shaft installation plan for conformance with the plans, specifications, and special provisions. The drilled shaft installation plan shall provide detailed drilled shaft installation information including the following:

1. List of proposed equipment to be used including cranes, drills, augers, bailing buckets, final cleaning equipment, desanding equipment, concrete coring equipment, soil sampling equipment, slurry pumps, tremie, concrete pumps, casing, etc.
2. Details of the safety plan developed for this project.
3. Details of the overall construction operation sequence and the proposed sequence of shaft construction.

4. Details of planned shaft excavation methods and final shaft dimensions.
5. Details of proposed excavation and concrete placement contingency plans including a list of equipment or materials required.
6. Details of the slurry type, mixing method, sampling and testing method, circulating and desanding method, and disposal method, when the slurry method of construction is to be used.
7. Details of equipment and proposed methods to clean the drilled shaft excavation.
8. Details of reinforcement positioning including support and centering methods.
9. Details of concrete placement methods, curing, and protection. Details shall include concrete placement operational procedures for free fall, tremie, or pumping as appropriate.
10. Details of Crosshole Sonic Logging testing including proposed testing schedule, when required.
11. Other information shown in the plans or special provisions.

No changes shall be made to the drilled shaft installation plan without approval from the engineer.

814.06 PROTECTION OF EXISTING STRUCTURES AND UTILITIES. The contractor shall control his operations to prevent damage to existing structures and utilities. Preventative measures shall include, but are not limited to, selecting construction methods and procedures that will prevent caving of the drilled shaft excavation, and controlling the vibrations from construction activities.

814.07 SAFETY REQUIREMENTS. The contractor shall take whatever measures are necessary to insure the safety of all persons including the general public in accordance with Section 107. The following safety topics are presented as representative of issues that the contractor must address. This list is not intended to be all-inclusive and does not relieve the contractor of conforming to other regulations, laws, requirements, or other measures reasonably required for safe excavating operations.

(a) Excavation Equipment: Any required equipment within an excavation shall be operated by air or electricity. The use of gasoline-driven engines or diesel engines within an excavation shall not be permitted.

(b) Lighting: All lighting shall be electric and precautions shall be taken to prevent potential short circuits of electric current within ground water.

814.07

(c) Explosive or Noxious Gases: The contractor shall take precautions to assure that no explosive or noxious gases are present. Fresh air shall be supplied into the excavation whenever any personnel are present in the excavation.

(d) Excavation Entry: A safety harness or chair lift, with separate safety line, and two-way radio communication shall be used for any entry into the excavation.

(e) Open Excavations: No open excavations shall be left unattended. During non-working hours, excavations shall be protected by the use of solid, safe covers that are firmly fastened in place.

(f) Completed Drilled Shafts: When the elevation at the top of the completed drilled shafts is below the ground elevation, and steel reinforcement remains exposed, the contractor shall seal the opening at the ground surface to prevent injury.

814.08 EXCAVATION METHODS. The contractor's methods and equipment shall be suitable to perform the excavations required for the shafts.

The contractor shall provide equipment capable of constructing shafts to a depth equal to the deepest shaft shown in the plans plus 16 feet (5 m).

Drilled shafts shall generally be constructed by the dry method, wet method, temporary casing method, or permanent casing method as necessary to produce sound, durable concrete foundation shafts free of defects. The permanent casing method shall be used only when required by the plans or authorized by the engineer. When the plans describe a particular method of construction, this method shall be used except when otherwise permitted by the engineer. When the plans do not describe a particular method, the contractor shall propose a method on the basis of its suitability to the site conditions and submit it for approval with his drilled shaft installation plan submittal.

The contractor shall set a suitable temporary surface casing. The minimum surface casing length shall be the length required to prevent caving of the surface soils and to aid in maintaining shaft position and alignment. Predrilling with slurry and/or overreaming to the outside diameter of the casing may be required to install the surface casing at some sites.

The bridge end embankments shall be completed prior to excavating drilled shafts for the end bents.

(a) Dry Construction Method: The dry construction method shall be used only at sites where the ground water table and soil conditions make it feasible to construct the shaft.

The dry construction method consists of drilling the shaft excavation, removing accumulated seepage water and loose material from the excavation, and placing the shaft concrete in a relatively dry excavation.

The dry construction method shall be used only when shaft excavations, as demonstrated in a trial shaft or test drilled shaft, have 12 inches (300 mm) or less of seepage water accumulated over a one hour period without pumping, the sides and bottom remain stable without detrimental caving, sloughing, or swelling for a four hour period, and the loose material and water can be satisfactorily removed prior to inspection and prior to placing concrete.

(b)Wet Construction Method: The wet construction method consists of drilling the shaft excavation below the water table, keeping the shaft filled with a slurry, desanding and cleaning the slurry, and cleaning the final excavation by means of a clean out bucket, air lift, submersible pump or other approved device. The shaft concrete shall be placed with a tremie or concrete pump beginning at the shaft bottom to displace the slurry as the shaft excavation is concreted.

Where drilled shafts are located in open water, the shafts shall be constructed by the wet method using exterior casings extending from above the water elevation into the ground to protect the shaft concrete from water action during placement and curing of the concrete. The exterior casing shall be installed in a manner that will produce a positive seal at the bottom of the casing so there is no intrusion or extrusion of slurry, water or other materials into or out of the shaft excavation.

(c) Temporary Casing Construction Method: The temporary casing method consists of advancing the hole through caving material by the wet method described above. When a cohesive soil formation is reached, a casing shall be placed in the hole and sealed to prevent seepage. Drilling may proceed as with the dry method to the projected depth. Temporary casings shall extend sufficiently above the grade of the finished drilled shaft to provide for excess concrete to be placed for the anticipated subsidence of concrete due to casing removal. The placement of the concrete shall proceed as with the dry method except that the casing shall be withdrawn when the concrete is placed. In the event that, seepage conditions prevent the use of the dry method, excavation shall be completed using wet methods.

Where drilling is through materials having a tendency to cave, the drilling shall be advanced by drilling in a slurry. In the event that a caving layer or layers are encountered that cannot be controlled by slurry, the contractor shall

814.07

install temporary casing through such caving layer or layers. Overreaming to the outside diameter of the casing may be required. The contractor shall take whatever steps are required to prevent caving during shaft excavation including installation of deeper casings. If the contractor elects to remove a casing and replace it with a longer casing through caving soils, he shall adequately stabilize the excavation with slurry or backfill the excavation. Soil previously excavated or soil from the site may be used if the excavation is backfilled.

Before the casing is withdrawn, the level of fresh concrete shall be such that the fluid trapped behind the casing is displaced upward. As the casing is withdrawn, care shall be exercised to maintain the level of concrete within the casing so that fluid trapped behind the casing is displaced upward out of the shaft excavation without mixing with or displacing the shaft concrete.

The casing method may be used, when approved by the engineer, to construct drilled shafts through weak caving soils that do not contribute significant shaft shear resistance. In this case, a temporary casing is placed through the weak caving soils before excavation begins. Excavation is conducted using the dry or wet construction method as appropriate. The temporary casing shall be removed during the concreting operations unless approved otherwise by the engineer.

(d)Permanent Casing Construction Method: The permanent casing method shall be used when required in the plans. In this method, a casing is placed to the prescribed depth before excavation begins. If full penetration cannot be attained, the engineer may direct the excavation through the casing and the casing advanced again until reaching the desired penetration. In some cases, overreaming to the outside diameter of the casing may be required before placing the casing.

The casing is cut off at the prescribed elevation upon reaching the proper construction sequence and the remainder of the casing is left in place.

814.09 EXCAVATION PROCEDURES AND CONDITIONS.

(a) Soil Sampling: The plans generally indicate the expected depths, the top of the shaft elevations, and the estimated bottom of shaft elevations between which the drilled shaft shall be constructed as a minimum. Drilled shaft excavations may be extended deeper when the engineer determines that the material encountered while drilling the shaft excavation is unsuitable and/or is not the same as the material anticipated in the design of the drilled shaft.

The contractor shall take soil samples, when shown in the plans or directed by the engineer, to determine the character of the material directly below the drilled shaft excavation. The soil sampling method shall be capable of obtaining representative material samples encountered at the bottom of the drilled shaft excavation. Sampling tools such as core barrels, split spoon sampler, or undisturbed sample tubes and sampling procedures shall be approved by the engineer. The soil samples shall be taken to a maximum depth of 5 feet (1.5 m) below the bottom of the drilled shaft excavation. The engineer will inspect the samples and determine the depth of required excavation.

(b)Excavation Log: The contractor shall maintain a drilling log during shaft excavation and during sampling operations. The log shall contain information such as the description of and approximate top and bottom elevations of each stratum encountered, depth of penetration, drilling time in each of the various strata, material description, and remarks. Two copies of the drilling log, signed by a designated representative of the contractor, shall be furnished to the engineer.

(c) Excavated Material: Excavated materials which are removed during drilled shaft construction and are not used elsewhere on the project shall be disposed of by the contractor in accordance with Subsection 202.02.

(d)Excavation Contingencies: The contractor shall have readily available all equipment and materials necessary for mitigating situations that may occur during drilled shaft excavation, such as caving or sloughing of the excavation sides, slurry problems, such as loss of slurry through permeable media, excessive seepage, unsuitable bearing material, etc. Contingency solutions may consist of a change in excavation method, slurry additives, sampling tools, etc. Contingency methods shall be submitted with the installation plan for approval.

(e) Overreaming: When excavation time limits described in Subsection 814.13(d) are exceeded, sidewall overreaming shall be required when the sidewall of the hole is determined to have either softened due to excavation methods, swollen due to delays in concreting, or degraded because of slurry cake buildup. Depending on the condition of the sidewall, the drilled shaft diameter shall be overreamed by increasing the diameter of the drilled shaft between 1 to 6 inches (25 to 150 mm). The extent of sidewall overreaming shall be as directed by the engineer. Overreaming may be accomplished with a grooving tool, overreaming bucket or other approved equipment. The contractor shall bear all costs associated with both sidewall overreaming and additional shaft concrete placement.

814.07

(f) Adjacent Drilled Shaft Construction: Adjacent shafts within 3 shaft diameters (center to center) shall not be excavated or casings placed until 48 hours have elapsed from the completion of the pour of the previous drilled shaft. Production drilled shaft construction may continue on other shafts.

(g) Lost Tools: Drilling tools that are lost in the excavation shall be promptly removed by the contractor. All costs due to lost tool removal shall be borne by the contractor including but not limited to costs associated with the repair of hole degradation due to removal operations or time limits being exceeded during the period the excavation remains open.

814.10 PERMANENT CASING. Permanent casing type, size, and length, shall be as specified in the plans. Casing shall be steel, smooth, clean and watertight and shall be free of accumulations of hardened concrete both inside and outside. It shall be of ample strength to withstand both handling and driving stresses during installation.

(a) Casing Placement: The casing shall be continuous between top and bottom elevations prescribed in the plans. After installation is complete, the permanent casing shall be cut off at the prescribed elevation and the shaft completed by installing necessary reinforcing steel and concrete in the casing.

(b) Casing Coating: When casing coating is specified in the plans or required by the engineer, the exterior surfaces of permanent casings shall be painted with a cold tar epoxy-polyamide paint as described in the plans and in accordance with Section 811. The exterior surfaces shall be coated prior to the installation of the casings. After the installation of the casings, all damage to the coated surfaces of the casing exposed to the air shall be repaired by a reapplication of the coating system.

814.11 TEMPORARY CASING. Temporary casings shall be made of steel of ample strength to withstand handling and driving stresses, and the pressure of concrete and of the surrounding earth. The casing shall be smooth, watertight, and clean and free of accumulations of hardened concrete. The inside diameter of casings shall not be less than the specified shaft size. No extra compensation will be allowed for concrete required to fill an oversized casing or excavation.

(a) Casing Removal: Temporary casing removal may occur gradually as concrete is placed. Movement of the casing by rotating, exerting downward pressure and tapping it to facilitate extraction, or extraction with a vibratory hammer, will be permitted. Casing extraction shall be at a slow, uniform rate with the pull in line with the axis of the shaft. Temporary casings shall be

removed while the concrete remains workable. When conditions warrant, the casing may be pulled in partial stages. A sufficient head of concrete shall be maintained above the bottom of the casing to overcome the hydrostatic pressure of water outside the casing. At all times the elevation of the concrete in the casing shall be maintained high enough to displace the drilling slurry between the outside of the casing and the edge of the hole as the casing is removed. Casings that, in the opinion of the engineer, will not adversely affect the shaft capacity may be left in place when approved by the engineer.

(b) Bound and Fouled Casings: Shafts constructed with temporary casings that become bound or fouled during shaft construction and cannot be practically removed, shall be considered defective. The contractor shall be responsible for correcting the defective shaft, with modifications required to compensate for loss of frictional capacity in the cased zone.

If upward movement of the concrete and/or reinforcing steel occurs at any time during the pulling operation, the following criteria shall govern:

1. If the upward movement is 1 inch (25 mm) or less, the casing may continue to be pulled provided no further movement occurs. If directed by the engineer, the concrete shall be vibrated or rodded in the upper 5 feet (1.5 m), to reconsolidate the concrete after the casing is withdrawn. Vibration or rodding shall not be used to attempt to break the casing loose for extraction.

2. If the upward movement is greater than 1 inch (25 mm), the drilled shaft shall be considered defective and the contractor shall be responsible for correcting the defective drilled shaft. Subject to the approval of the engineer, one of the following corrective options may be used.

a. The casing may be left in place as a permanent sleeve and the concrete vibrated or rodded to reconsolidate the concrete. The contractor shall obtain concrete core samples and/or conduct approved nondestructive testing.

If the concrete core sampling or nondestructive testing are not conclusive, the engineer may require the contractor to perform a load test or other tests to determine the adequacy and acceptability of the drilled shaft. The contractor shall be responsible for modifications required to compensate for loss of frictional capacity in the cased zone when the temporary casing is abandoned in the shaft. All such modifications including leaving the casing in place, and all testing shall be at no additional cost to the Department.

b. All drilled shaft materials shall be removed and the shaft redrilled.

(c) Removable Casings: Use of removable casings or special casing systems shall be subject to written approval from the engineer. These casings shall be removed in a manner that will not damage the exposed drilled shaft

814.07

concrete after hardening. These casings can be removed when the concrete has attained sufficient strength provided the following criteria are met.

1. Curing of the concrete is continued for the full curing period in accordance with the specifications.

2. Shaft concrete is not exposed to salt water or moving water for seven days or until reaching a compressive strength of at least 2500 psi (17.3 MPa).

814.12 SLURRY. When slurry is employed in the drilling process as in the wet construction method, mineral slurry or polymer slurry may be used in accordance with these specifications. The contractor shall provide a list of construction projects, within the past three years, where the proposed slurry has been used to construct drilled shafts in comparable site conditions as those anticipated for the required drilled shafts. The project list shall contain names and telephone numbers of owner's representatives who can verify the field performance of the proposed slurry.

All equipment in contact with the water or slurry during mixing or transporting to the excavation, such as mixing tanks, pumps, and water lines, shall be free of fresh concrete residue.

(a) Polymer Slurry:

(1) Approval Process: Polymer slurries and additives may be used when approved in writing by the DOTD Chief Construction Engineer. The request for approval of a polymer slurry shall be included with the drilled shaft installation plan. The following information shall be furnished with the submittal:

a. The manufacturer's specifications for polymer slurry and any additives.

b. Recommended instructions for proper slurry mixing

As a prerequisite to final approval of the polymer slurry, the Department may require construction of a trial shaft in accordance to Subsection 814.21 to evaluate the slurry's performance during drilled shaft construction. A manufacturer's representative shall be present during construction of the trial shaft or test drilled shaft to instruct DOTD and the contractor's personnel in the proper testing and construction techniques for the proposed polymer slurry.

(2) Polymer Slurry Requirements: The approved polymer slurry shall have sufficient viscosity to stabilize the shaft excavation and sufficient positive pressure head to inhibit the influx of ground water into the excavated hole. The material used to make the slurry shall not be detrimental to concrete

or surrounding ground strata. Control testing using suitable apparatus shall be carried out on the polymer slurry mixture by the contractor to determine the density, sand content, viscosity, and pH. Tests shall be performed when the slurry temperature is above 40°F (5°C). Acceptable values for these physical properties are shown in Table 814-1.

**Table 814-1
Polymer Slurry Specifications**

Property (Units)	At Time of Slurry Introduction	In Hole at Time of Concreting	Test Method
Density	63-64 pcf (1010 - 1026 kg/m ³) (fresh water)	63-64 pcf (1010 - 1026 kg/m ³) (fresh water)	Mud Balance (API 13B-Sec 1)
Viscosity (minimum)	45 seconds	N/A	Marsh Funnel (API 13B-Sec 2)
pH	8 – 10	8 – 10	pH Paper pH Meter (API 13B-Sec 6)
Max. Sand Content (% by Volume)	1	1	Sand Screen Set (API 13B- Sec 4)

The limits shown in Table 814-1 may be adjusted when field conditions warrant as demonstrated by a trial shaft, test drilled shaft, or other methods approved by the engineer.

(3) Polymer Slurry Mixing: The polymer slurry shall be mixed thoroughly with clean fresh water in a separate mixing tank with a high shear agitating mixer. Water hardness shall be tested prior to mixing to insure it meets the manufacturer's recommendations. The contractor shall take all steps necessary to prevent the slurry from losing the required viscosity.

(b)Mineral Slurries:

(1) Mineral Slurry Requirements: Mineral slurry shall consist of processed attapulgite, sepiolite, or bentonite clays containing pure sodium bentonite. The slurry shall have a mineral grain size such that it will remain in suspension and shall have sufficient viscosity and gel characteristics to transport excavated material to a suitable screening system. The percentage and specific gravity of the material used to make the suspension shall be sufficient to maintain the stability of the excavation and to allow proper placement of concrete. The material used to make the slurry shall not be detrimental to concrete or surrounding ground strata.

814.11

The contractor shall take the steps necessary to prevent the slurry from "setting up" in the shaft excavation, including but not limited to, agitation, circulation and/or adjusting the composition and properties of the slurry.

Control testing using suitable apparatus shall be carried out on the mineral slurry mixture by the contractor to determine density, sand content, viscosity, and pH. Tests shall be performed when the slurry temperature is above 40°F (5°C). Acceptable values for these physical properties are shown in Table 814-2.

Table 814-2
Mineral Slurry Specifications

Property (Units)	At Time of Slurry Introduction	In Hole at Time of Concreting	Test Method
Density	64.3 - 69.1 pcf (1030 - 1107 kg/m ³) (fresh water)	64.3 - 75.0 pcf (1030 - 1202 kg/m ³) (fresh water)	Mud Balance (API 13B- Sec 1)
Viscosity	28 - 45 seconds	N/A	Marsh Funnel (API 13B- Sec 2)
pH	8 - 11	8 - 11	pH Paper pH Meter (API 13B-Sec 6)
Max. Sand Content (% by Volume)	4	4	Sand Screen Set (API 13B- Sec 4)

The limits in Table 814-2 may be adjusted when field conditions warrant as demonstrated by a trial shaft, test drilled shaft, or other methods approved by the engineer.

(2) Mixing and Storage: The mineral slurry shall be premixed thoroughly with clean fresh water prior to introduction into the shaft excavation. When bentonite slurry is used, it should be held in storage for a period of time to allow complete hydration. The percentage of mineral admixture used to make the suspension shall be adequate to maintain the stability of the shaft excavation. Adequate water and/or slurry tanks are required when necessary to perform the work in accordance with these specifications. No excavated pits will be allowed without the written permission of the engineer. No mixing of slurry will be allowed in the drilled shaft excavation. Slurry shall not stand for more than four hours in the excavation without agitation. If this is not possible, the drilled shaft excavation shall be overreamed to remove filter cake.

(3) Desanding: Desanding equipment shall be provided by the contractor as necessary to control slurry sand content unless otherwise directed in the plans or special provisions. Desanding equipment will not be required

for construction of drilled shafts for sign post or lighting mast foundations unless shown in the plans or special provisions.

(c) Slurry Testing Frequency: Density, viscosity, sand content, and pH testing shall be performed initially until a consistent working pattern has been established, taking into account the mixing process, and blending of freshly mixed slurry and previously used slurry. Density, viscosity, sand content, and pH value testing shall be performed a minimum of four times during the first eight hours the slurry is in use.

Prior to placing concrete in any shaft excavation, the contractor shall ensure that heavily contaminated suspensions, which could impair the free flow of concrete from the tremie pipe, have not accumulated in the bottom of the shaft. Samples of the slurry in the shaft shall be taken from the base of the shaft and at intervals not exceeding 10 feet (3 m) up the shaft, using an approved sampling tool, until two consecutive samples produce acceptable values in accordance with slurry specifications for polymer and mineral slurries.

(d) Unacceptable Slurry Test Results: When any slurry samples are tested and found to be unacceptable, the contractor shall take whatever action is necessary to bring the slurry within specification requirements. Concrete shall not be poured until resampling and testing results produce acceptable values.

(e) Slurry Test Reports: Reports of all slurry tests required above, signed by an authorized representative of the contractor, shall be furnished to the engineer upon completion of each drilled shaft.

(f) Slurry Disposal: Disposal of all waste slurry shall be off-site in suitable areas provided by the contractor in accordance with local, state, and federal laws.

(g) Required Fluid Level: During construction, the slurry shall be maintained within the excavation at a level not less than 5 feet (1.5 m) above the highest expected piezometric water head within the shaft excavation. The slurry level may be higher if caving or sloughing soils are present above this level.

(h) Slurry Performance: If the slurry fails to stabilize the excavation, or if a sudden significant loss of slurry occurs such that the slurry level cannot practically be maintained by adding slurry to the hole, the construction of that

814.11

foundation shall be continued by the approved contingency method. Construction of new drilled shafts shall be discontinued until the contractor modifies or replaces the existing drilled shaft construction method and obtains written approval from the engineer.

(i) Blended Mineral-Polymer Slurry: If the contractor elects to use blended mineral-polymer slurry, a detailed report shall be submitted specific to the project, prepared by a qualified slurry consultant. The report shall describe slurry materials, mix proportions, mixing methods and quality control methods. Details of the slurry quality control testing criteria shall also be furnished. A manufacturer's representative shall be present during construction of the trial shaft to provide guidance on the proper proportions, mixing and quality control of the blended mineral-polymer slurry.

814.13 EXCAVATION INSPECTION AND REQUIREMENTS.

(a) Dimensions and Alignment: The contractor shall provide equipment for checking the dimensions and alignment of each permanent shaft excavation. The dimensions and alignment of the shaft excavation shall be determined by the contractor under the observation and direction of the engineer. The alignment and dimensions shall be checked by any of the following methods:

1. Check the dimensions and alignment of dry shaft excavations using reference stakes and a plumb bob.

2. Check the dimensions and alignment of casing when inserted in the excavation.

3. Insert a casing in the shaft excavations temporarily for alignment and dimension checks.

4. Other methods provided by the contractor and approved by the engineer.

Any casing, rod, or other device used to check dimensions and alignment shall be inserted by the contractor into the excavation to full depth.

(b) Depth: The depth of the shaft during drilling shall generally be referenced to appropriate marks on the Kelly bar or by other suitable methods. Final shaft depths shall be measured with a suitable weighted tape or other approved method.

(c) Drilled Shaft Cleanliness Requirements: The contractor's cleaning operation shall be adjusted so that no more than 1/2 inch (15 mm) of loose or disturbed material shall be present at the bottom of the shaft just prior to placing concrete for end bearing drilled shafts. No more than 2 inches (50

mm) of loose or disturbed material shall be present for side friction shafts. End bearing shafts shall be assumed unless otherwise noted in the plans, or directed by the engineer.

Drilled shaft bottom cleanliness will be determined by visual inspection for dry shafts or other methods deemed appropriate by the engineer for wet drilled shafts. The device proposed to check for bottom cleanliness shall be approved by the engineer prior to use. The bottom of the drilled shaft excavation shall be cleaned, regardless of the method of load distribution, with a cleanout bucket or other appropriate tool. When a cleanout bucket is used, it shall be equipped with a one-way flap gate that prevents spoil in the bucket from re-entering the drilled shaft excavation. End bearing drilled shafts, drilled by the wet construction method, shall require a final bottom cleaning with an air-lift or submersible pump prior to concrete placement. Care shall be taken not to decrease the borehole stability while utilizing the air-lift or submersible pump.

In addition, for dry excavations the maximum depth of water covering the bottom of the excavation shall not exceed 3 inches (75 mm) prior to concrete placement.

(d) Time of Excavation: No drilled shaft excavation work shall be open for more than 36 hours prior to placing concrete. The excavation time shall start at the beginning of excavation for all construction methods except the permanent casing method, which starts at the time the excavation begins below the permanent casing. If slurry is used, the contractor shall adjust his excavation operations so that the maximum time slurry is in contact with the bottom 5 feet (1.5 m) of the drilled shaft excavation does not exceed 12 hours from drilling to concreting. If these time limits are exceeded, the drilled shaft excavation may require overreaming of the sidewalls and/or overdrilling the excavation prior to performing other operations in the shaft. Costs associated with exceeding these time limits shall be at the contractor's expense.

814.14 REINFORCING STEEL CONSTRUCTION AND POSITIONING.

(a) Cage Construction and Placement: Fabrication and positioning of reinforcing steel shall conform to Section 806. The contractor shall order and fabricate the steel reinforcing cage after the final drilled shafts depths have been specified. The steel reinforcing cage, consisting of longitudinal and transverse bars, ties, and cage stiffener bars, shall be completely assembled and positioned as a unit immediately after the shaft excavation is inspected and accepted, and prior to concrete placement. The reinforcing cage shall be

814.12

rigidly braced to retain its configuration during handling and construction. If Crosshole Sonic Logging testing is required, the steel cage shall have attached to it the access tubes as described in Subsection 814.19.

(b) Cage Extension: If the drilled shaft bottom is extended to an elevation lower than the plan bottom elevation, the reinforcing cage length shall also be extended by the same amount. The reinforcing cage may be extended at the plan bottom elevation by using a lap splice or a mechanical butt splice device to attach additional longitudinal reinforcement in accordance with Section 806. Welding to extend the reinforcing steel shall not be permitted. Tie bars shall be continued for the extra depth, at the same spacing, and the stiffener bars shall be extended to the final depth.

(c) Support, Alignment and Tolerance: The reinforcement steel in the drilled shaft shall be carefully positioned and securely fastened and supported so that the reinforcing steel remains within the allowable tolerances given in Subsection 814.17(c).

(d) Spacers: Concrete wheels, with a minimum width of 1 inch (25 mm), or other non-corrosive rolling spacing devices, approved by the engineer, shall be placed at the top and bottom of the steel reinforcement cage and at sufficient intervals along the shaft to insure concentric spacing for the entire length of the steel reinforcement cage. Block type spacers will not be allowed. For longitudinal reinforcement less than 1 inch (25 mm) diameter, spacing devices shall be placed at intervals not exceeding 5 feet (1.5 m) along the shaft. For longitudinal reinforcement, 1 inch (25 mm) diameter or larger, spacing devices shall be placed at intervals not exceeding 10 feet (3 m) along the shaft. A minimum of one spacer per 3 feet (1 m) of circumference of cage with a minimum of three at each level shall be used. Additional spacers may be required if deemed necessary by the engineer. Concrete or other approved non-corrosive spacers, approved by the engineer, shall be provided at the bottom of the drilled shaft reinforcing cage to insure that the specified distance between the bottom of the cage and the bottom of the shaft is maintained. The bottom spacers shall be constructed of approved material equal in quality and durability to the concrete specified for the shaft. Bottom spacers will not be required if the steel reinforcing cage is supported at the top of the hole.

(e) Reinforcement Cage Elevation: The elevation of the top of the steel reinforcement cage shall be checked before and after the concrete is placed. If the reinforcement cage is not maintained within the specified tolerances, corrections shall be made by the contractor as directed by the engineer. No additional shafts shall be constructed until the contractor has

modified his reinforcement cage support in a manner satisfactory to the engineer.

(f) Column Steel: The minimum length of steel required for lap with column steel shall be maintained. Dowel bars in the top of the shaft shall be placed and tied prior to starting concrete pour unless approved otherwise by the engineer.

814.15 CONCRETE PLACEMENT METHOD. The contractor may use any of the placement methods described herein. Details pertaining to compliance with this specification shall be furnished in the contractor's drilled shaft installation plan.

(a) Free Fall Method:

(1) Requirements: The free fall placement of concrete shall only be permitted in dry vertical shafts where the clear opening (inside the reinforcing cage) is not less than 24 inches (600 mm) in diameter. The height of free fall placement shall not exceed 75 feet (23 m) measured from the bottom of the hopper or drop chute to the point of deposition. Concrete placed by free fall shall fall directly to the placement location without contacting either the reinforcing cage or the shaft sidewall.

A hopper shall be used at the top of the shaft to center and direct the free fall placement. The contractor shall reduce the rate of concrete placement or reduce the height of free fall as directed by the engineer if the concrete strikes the reinforcing cage or sidewall.

(2) Disqualification of Free Fall Method: If in the opinion of the engineer, concrete placement cannot be satisfactorily accomplished by the free fall method, the contractor shall change to either tremie or pumping methods to accomplish the concrete placement.

(b) Tremie and Pumped Concrete Placement Methods:

(1) Tremie: Tremies shall consist of a tube of sufficient length, weight, and diameter to discharge concrete at the shaft base elevation. Inside and outside surfaces of the tremie shall be clean and smooth to permit both flow of concrete and unimpeded withdrawal during concreting. The wall thickness of the tremie shall be adequate to prevent crimping or sharp bends that restrict concrete placement. The tremie's inside diameter shall be at least 6 times the maximum aggregate size used in the concrete mix but shall not be less than 10 inches (250 mm). Tremies shall be clearly marked at one foot increments. Tremies used for concrete placement in dry excavations shall consist of: a tube of solid construction; a tube constructed of sections which can be added and removed; or a tube of other approved design. Aluminum

814.12

tremies will not be allowed. Tremies used for concrete placement in wet excavations shall be constructed as follows:

1. The tremie pipe is watertight and discharges concrete readily
2. The discharge end of the tremie shall prevent intrusion of slurry
3. The discharge end of the tremie shall be constructed to permit the free radial flow of concrete during placement operations

4. The tremie shall have sufficient weight that it will rest on the shaft bottom before the start of concrete placement.

(2) Pumped Concrete: The contractor may use concrete pumps approved by the engineer in lieu of tremies to place concrete for drilled shafts. Concrete pumps shall have sufficient capacity to place the concrete within the time limit specified. The pump lines shall have a minimum 4 inch (100 mm) diameter and shall be constructed so that all sections have watertight joints.

(3) Concrete Placement: Tremied or pumped concrete may be used for concrete placement in either wet or dry excavations.

a. Dry Excavations: Concrete may be passed through a hopper at the top of the tremie or through side openings as the tremie is retrieved during concrete placement. The tremie or pump line shall be supported so that the free fall of the concrete is less than 5 feet (1.5 m) at all times. If the free falling concrete causes the shaft sides to cave or slough, the contractor shall control the movement of concrete by reducing the height of free fall of the concrete and/or reducing the rate of flow of concrete into the excavation.

b. Wet Excavations: When a tremie is used for concrete placement, bottom plates or plugs will be required to ensure that there is a minimum of concrete contamination. When a bottom seal is used, the tremie shall be sealed prior to placing the tremie in the wet excavation. The tremie pipe shall be placed on the bottom of the excavation and charged with concrete prior to lifting the tremie to release the bottom seal. The tremie should only be raised enough to release the bottom seal and start the flow of concrete, approximately 1 foot (300 mm). When a plug or pig is placed at the top of the tremie it shall be inserted after the tremie is placed in the wet excavation and before the tremie is charged with concrete. The bottom of the tremie shall be placed slightly off the bottom of the excavation to allow the plug or pig to pass out of the tremie.

When a concrete pump with rigid steel pump line is used for concrete placement, a plug or pig is to be placed in the rigid pump line to minimize concrete contamination. The plug or pig is to be placed near the top of the rigid line after the rigid line has been placed in the wet excavation and before

the rigid line is connected to the surface line from the pump. The rigid pump line shall be equipped with a vent to prevent air pressure build up in the surface line at the beginning of concrete pumping operations. The air vent shall be closed when the concrete in the surface line reaches the pig in the rigid line.

The discharge end of the tremie or rigid pump line shall be immersed at least 5 feet (1.5 m) into the concrete at all times and shall not be removed after starting the flow of concrete. The flow of the concrete shall be continuous. The concrete in the tremie or pump line shall be maintained with a positive head at all times to prevent water or slurry intrusion into the shaft concrete. If at any time during the concrete pour, the tremie or pump line discharge end is removed from the fluid concrete column and discharges concrete above the rising concrete level, the shaft shall be considered defective. The contractor shall have the option, at the time the concrete pour is interrupted, to recharge the tremie and continue the pour at his own risk or to remove the reinforcing cage and concrete, complete any necessary sidewall overreaming as directed by the engineer, and repour the shaft.

814.16 CONCRETE PLACEMENT REQUIREMENTS. Concrete shall be placed in accordance with Section 805 and the requirements herein.

(a) Concrete Placement Responsibility: The drilled shaft contractor shall be responsible for placement of the concrete in the drilled shaft. Prior to concrete placement, the drilled shaft contractor shall make all necessary arrangements to assure the uninterrupted delivery of concrete so that all drilled shaft foundations shall be constructed without cold joints.

(b) Concrete Placement Contingencies: The contractor shall have readily available all equipment and materials necessary for mitigating situations that may occur during drilled shaft concrete placement such as unforeseen stoppage of work, drop in concrete pressure, delays in concrete placement, etc. Contingency methods shall be submitted with the drilled shaft installation plan for approval.

(c) Concrete Placement Log: When concrete placement is under slurry, or as directed by the engineer, a concrete placement log will be maintained to document the method of concrete placement. The contractor shall assist the engineer in determining the actual volume of concrete placed, elevation of top of concrete in the shaft, and elevation of tremie or pump line discharge end.

(d) Concrete Placement Time Limitations: Concrete shall be placed as soon as possible after the reinforcing steel placement and shall be

814.15

continuous from the bottom to the top elevation of the shaft. Concrete placement shall continue after the shaft excavation is full, until good quality concrete is evident at the top of the drilled shaft. Unless approved otherwise by the engineer, the elapsed time from beginning to completion of concrete placement in the drilled shaft shall not exceed two hours for drilled shafts 5 feet (1.5 m) diameter or less. The minimum concrete placement rate for drilled shafts larger than 5 feet (1.5 m) diameter shall be 30 cubic yards (23 cu m) per hour.

The engineer may allow an extension of the concrete placement time if the contractor adequately demonstrates by trial mix and slump loss tests that the slump of the concrete will be no less than 4 inches (100 mm) during the entire time of concrete placement during the longer placement time.

These tests shall be conducted by a DOTD certified concrete technician in the presence of the engineer. The slump loss tests shall be performed at intervals not to exceed 30 minutes and shall be made from a trial mix proportioned from the approved concrete mix design. The temperature of the trial mix shall be kept at a level representative of construction site conditions. A slump loss versus time curve shall be furnished to the engineer prior to concreting production shafts.

(e) Top of Drilled Shaft: Concrete placed under slurry shall not be vibrated, unless directed by the engineer, in the top 5 feet (1.5 m) of the drilled shaft after the slurry, contaminated concrete, and surface casing have been removed. After concrete placement is completed, the top surface shall be cured and construction joint areas shall be treated as specified in Section 805.

Concrete placement in wet excavations shall be overpoured until all slurry and contaminated concrete has been removed. Temporary sump holes used for slurry recovery and concrete overpour shall not exceed 5 feet (1.5 m) in depth. The temporary sump holes shall be cleaned out and backfilled to the satisfaction of the engineer.

814.17 DRILLED SHAFT CONSTRUCTION TOLERANCES. The following construction tolerances shall apply for drilled shafts unless otherwise stated in the contract documents. During drilling or excavation of the drilled shaft, the contractor shall make frequent checks on the plumbness, alignment, and dimensions of the shaft. Drilled shafts constructed out of tolerance are unacceptable and shall be considered defective. These out of tolerance shafts shall be backfilled, in an approved manner, when directed by the engineer until the redesign is completed and approved.

(a) Horizontal Location: When drilled shafts support a single column, the center of the top of the drilled shaft shall vary no more than 3 inches (75 mm) in the horizontal plane of the position indicated in the plans. The top of all other drilled shafts shall be constructed so that the center is within the following tolerances of the position indicated in the plans unless otherwise directed by the engineer.

**Table 814-3
Drilled Shaft Horizontal Tolerance**

Drilled Shaft Diameter, D		Horizontal Tolerance	
D ≤ 2 feet	D ≤ 600 mm	3 inches	75 mm
2 < D ≤ 3 feet	600 < D ≤ 900 mm	3 1/2 inches	90 mm
3 < D ≤ 4 feet	900 < D ≤ 1200 mm	4 inches	100 mm
D > 4 feet	D > 1200 mm	6 inches	150 mm

(b) Excavation Vertical Alignment: The vertical alignment of the shaft excavation shall be within 1.5 percent of plumb.

(c) Reinforcing Steel Cage: After all the concrete is placed, the top of the reinforcing steel cage shall be no more than 4 inches (100 mm) above and no more than 3 inches (75 mm) below plan position, and shall be at least 1 inch (25 mm) below the top of the shaft. When the shaft reinforcing cage is to be tied directly to the column steel the shaft reinforcing cage shall be within 1/2 inch (15 mm) of the plan location. On all other shafts, the reinforcing cage shall be concentric with the shaft within a tolerance of 1 1/2 inches (40 mm).

(d) Top Elevation of Shafts: The top elevation of the drilled shaft concrete shall be within 2 inches (50 mm) of the top of shaft elevation shown in the plans.

(e) Drilled Shaft Diameter: The minimum diameter of the drilled shaft shall be the diameter shown in the plans.

(f) Excavation Equipment And Methods: Excavation equipment and methods shall be designed so that the completed shaft excavation will have a flat bottom and shall be normal to the axis of the shaft within 3/4 inch per foot (60 mm/m) of drilled shaft diameter. The cutting edges of excavation equipment shall be normal to the vertical axis of the equipment within a tolerance of plus or minus 3/8 inch per foot (30 mm/m) of drilled shaft diameter.

814.15

814.18 DEFECTIVE DRILLED SHAFTS. The contractor shall be responsible for correcting defective drilled shafts, including redesign, to the satisfaction of the engineer. All corrective proposals to restore or replace defective drilled shafts shall be reviewed for approval by the Department. Corrective actions may consist of, but are not limited to: removing the shaft concrete and extending the shaft deeper, providing straddle shafts, or providing a replacement shaft. No compensation will be paid for abandoned casings, concrete, etc. that remain in place. When the drilled shaft is found defective, core sampling and additional nondestructive testing shall be at no direct pay. If the shaft is accepted, only core sampling and grouting, will be paid for by the Department. A unit price for coring will be established prior to the coring operations.

814.19 NONDESTRUCTIVE TESTING OF DRILLED SHAFTS. The nondestructive testing (NDT) method termed Crosshole Sonic Logging (CSL) shall be used to check the integrity of newly-placed concrete drilled shafts. The CSL testing system shall measure the time it takes for an ultrasonic pulse to travel from a signal source in one access tube to a receiver in another access tube.

The CSL test shall be used on all production shafts, trial shafts, and test drilled shafts when any of the following conditions occur:

1. A drilled shaft is constructed with the placement of concrete through slurry.
2. A full-length casing is used to prevent water from entering the shaft.
3. Determined to be necessary by the engineer.

The installation of access tubes and dewatering/grouting the tubes after the CSL testing has been performed shall be at no direct pay.

(a) NDT Consultant: The NDT consultant shall be an experienced independent test organization approved by the engineer prior to testing. All CSL testing and analyses shall be performed under the supervision of a registered professional engineer in the State of Louisiana. The NDT consultant shall have a minimum of three years experience in field testing and analyses of CSL test results.

(b) Testing Schedule: The CSL testing for all drilled shafts shall not be conducted until 24 hours after the placement of all concrete in a shaft. After placement of concrete, all CSL tests for production drilled shafts must be completed within 48 hours for PVC access tubes and 20 calendar days for steel access tubes. CSL tests for trial shafts and test drilled shafts must be

completed within 48 hours after placement of concrete. During the development of the CSL testing schedule, the contractor shall consider the CSL testing time constraints and the drilled shaft production schedule.

(c) Access Tubes: Access tubes used for production drilled shafts shall be 2.0 inch (50 mm) inside diameter schedule 40 steel pipe or PVC pipe. The pipes shall have a round, regular internal diameter free of defects or obstructions, including pipe joints, in order to permit the free, unobstructed passage of a 1.3 inch (33 mm) diameter source and receiver probes. The tubes and joints shall be watertight and free from corrosion with clean internal and external faces to ensure passage of the probes and a good bond between the concrete and the tubes.

Access tubes shall be installed for the full depth of each shaft to permit access of CSL testing equipment. The number of access tubes installed shall depend on the diameter of the shaft as specified in Table 814-4.

Table 814-4
Drilled Shaft Access Tubes for CLS Testing

Shaft Diameter, D (Feet)	Shaft Diameter, D (m)	Minimum Number of Access Tubes
$D < 2.5$	$D < 0.75$	2
$2.5 < D \leq 3.5$	$0.75 < D \leq 1.00$	3
$3.5 < D \leq 4.5$	$1.00 < D \leq 1.40$	4
$4.5 < D \leq 5.5$	$1.40 < D \leq 1.70$	5
$5.5 < D \leq 6.5$	$1.70 < D \leq 2.00$	6
$6.5 < D \leq 7.5$	$2.00 < D \leq 2.30$	7
$7.5 < D \leq 8.5$	$2.30 < D \leq 2.60$	8
$8.5 < D \leq 9.0$	$2.60 < D \leq 2.80$	9
$9.0 < D \leq 10.0$	$2.80 < D \leq 3.10$	10
$10.0 < D \leq 11.0$	$3.10 < D \leq 3.40$	11
$11.0 < D \leq 12.0$	$3.40 < D \leq 3.70$	12

The pipes shall each be fitted with a watertight shoe on the bottom and a removable cap on the top. The pipes shall be securely attached to the interior

814.15

of the reinforcement cage. The engineer may allow the tubes to be installed on the outside of the cage if the access tubes have a minimum concrete cover of 3 inches (75 mm) and bumpers are installed on the outside of the cage to prevent tubes from being crushed. The tubes shall be installed in each shaft in a regular, symmetric pattern such that each tube is equally spaced from the others around the perimeter of the cage. The tubes shall be as near to parallel and vertical as possible. The tubes shall be fastened to the reinforcement cage at 5 feet (1.5 m) intervals or as directed by the engineer. The tubes shall extend from 6 inches (150 mm) above the shaft bottom to at least 3 feet (1 m) above the shaft top. If the shaft top is subsurface, the tubes shall extend at least 3 feet (1 m) above the ground and/or water surface. Care shall be taken during reinforcement installation operations in the drilled shaft hole so as not to damage the tubes. Within 2 hours after concrete placement, the access tubes shall be filled with clean water and the tube tops capped or sealed to keep out debris. Care shall be exercised in the removal of caps or plugs from the pipes after concrete placement so as not to apply excess torque, hammering, or other stresses which could break the bond between the access tubes and the concrete.

(d) CSL Test Equipment: The CSL test equipment shall be capable of performing the following functions:

1. Displaying individual CSL records, recording CSL data, and analyzing receiver responses.
2. Printing of CSL logs.
3. Testing in 2 inch (50 mm) I.D. access tubes.
4. Generating an ultrasonic voltage pulse to excite the source with a synchronized triggering system to start the recording system.
5. Measuring and recording the depths of CSL probes at the time signals are recorded.
6. Filtering/amplifying signals.

(e) CSL Logging Procedures: The shaft identification, shaft bottom and top elevations, length, and date of concrete placement shall be provided to the NDT consultant prior to performing CSL testing. As a minimum, all perimeter tube pairs and major diagonal tube pairs shall be tested. If a possible defect is found, CSL testing shall be conducted between additional pairs of tubes as determined by the NDT consultant.

The CSL tests shall be carried out with the source and receiver probes in the same horizontal plane unless test results indicate potential defects in which

case the questionable zone may be further evaluated with angled tests consisting of the source and receiver vertically offset in the access tubes. CSL measurements shall be made at depth intervals of 2 inches (50 mm). The probes shall be pulled simultaneously, starting from the bottom of the tubes, over a depth measuring device. Any slack shall be removed from the cables prior to pulling to provide for accurate depth measurements.

(f) CSL Testing Results: A preliminary report shall be provided to the Pavement and Geotechnical Services Section within 72 hours of CSL testing. Two copies of the final CSL testing report shall be furnished to the engineer within 10 working days of testing. The test results shall include CSL logs

with analyses of the initial pulse arrival time versus depth and pulse energy/amplitude versus depth. A CSL log shall be presented for each tube pair tested with any defect zones indicated on the logs and discussed in the test report as appropriate. A summary of the CSL test results shall be included in the report. The CSL test summary shall include the drilled shaft identification, test date, shaft age at time of CSL testing (days from concrete placement to CSL testing), drilled shaft diameter, number of CSL tubes tested, test length, average compression velocity, and a description of anomalies detected. Each CSL anomaly description shall include CSL tube number, depth below top of concrete, percent concrete wave speed reduction, and recommended concrete condition rating.

(g)Evaluation of CSL Testing: The Geotechnical Engineer will evaluate the CSL test results and determine whether the drilled shaft construction is acceptable. The contractor shall allow three working days for the evaluation to be conducted after the receipt of the testing report and logs. In uniform good quality concrete, the CSL test will produce records with good signal amplitude and energy. Longer travel times or loss of signal and lower amplitude/energy signals indicate the presence of irregularities such as poor quality concrete, voids, honeycomb and soil intrusions. Any defects indicated by the testing shall be reported to the Geotechnical Engineer and further tests shall be conducted as required to evaluate the extent of such defects. Additional nondestructive testing to determine extent of defects or to determine if tube debonding has occurred shall be at no additional pay. If the Geotechnical Engineer determines that the drilled shaft is unacceptable based on CSL or other nondestructive testing, the shaft shall be considered defective.

(h)Abandoning CSL Access Tubes: After the CSL testing has been completed and the engineer has given approval to continue construction, the

814.15

contractor shall dewater and grout the access tubes in the drilled shaft. The grout and grouting method shall be approved by the engineer.

814.20 CORE DRILLING OF DRILLED SHAFT CONCRETE.

Production drilled shafts or test drilled shafts that are determined to be unacceptable by the CSL tests, or drilled shafts that, in the opinion of the engineer, are suspected to have defects, may be cored to determine the quality of the concrete. Number, depth, and location of cores shall be as determined by the engineer. Core samples shall be at least 2 inches (50 mm) in diameter. The methods and equipment used to core the drilled shaft and grout the cored hole shall be approved by the engineer prior to commencing coring operations.

(a) Concrete Core Log: An accurate log of cores shall be kept and the cores shall be placed in a crate and properly marked showing the shaft depth at each interval of core recovery. The engineer shall direct the contractor where to transport the cores along with a copy of the coring log.

(b) Concrete Core Sample Evaluation: Construction shall not proceed above a drilled shaft until the quality of the concrete in the shaft, as represented by the core samples, is determined to be acceptable and notification to continue construction is given by the engineer. If the quality of the concrete in a drilled shaft is determined to be unacceptable, then the drilled shaft shall be considered defective.

814.21 TRIAL SHAFTS. When shown in the plans or when ordered by the engineer in writing, trial shafts will be required. The construction of trial shafts will be used to determine if the methods and equipment used by the contractor are sufficient to produce a shaft excavation meeting the requirements of the plans and specifications. Trial shafts shall be constructed and approved prior to constructing production shafts. Trial shafts will be evaluated based on field observation and will not be finalized prior to receiving CSL results. The contractor will be evaluated during trial shaft excavations on his ability to:

1. Control dimensions and alignment of excavations within tolerances.
2. Seal the casing into impervious materials.
3. Control the size of the excavation under caving conditions by the use of slurry or by other means.
4. Properly clean the completed shaft excavation.

5. Construct excavations in open water areas.
6. Determine the elevation of ground water.
7. Satisfactorily place concrete meeting the specifications within the prescribed time frame.
8. Properly pick up and position the reinforcing cage.
9. Satisfactorily execute any other necessary construction operations.

The contractor shall revise his methods and equipment as necessary at any time during the construction of the trial shaft when he is unable to satisfactorily carry out any of the necessary operations described above.

(a) Location, Size, and Depth: The trial shaft shall be drilled at the location shown in the plans, or as directed by the engineer. If the diameter of the trial shaft is not shown in the plans, the trial shaft diameter shall be the diameter of the largest production drilled shafts required by the plans. If the depth of the trial shaft is not shown in the plans, the trial shaft depth shall be the depth of the deepest production drilled shaft, or as directed by the engineer.

(b) Construction Requirements: The trial shaft shall be constructed with a reinforcing cage containing the same reinforcing steel configuration as shown in the plans for the production shafts. The trial shaft shall be filled with concrete in the same manner that production reinforced drilled shafts will be constructed, unless directed otherwise by the engineer. The concreted trial shaft shall be left in place except that the top of the shaft shall be removed to a depth of 2 feet (600 mm) below the final ground line. This also shall apply to shafts constructed in water.

(c) Trial Shaft Evaluation: When the contractor fails to demonstrate, to the engineer, the adequacy of his methods or equipment, additional trial shafts shall be provided at no cost to the Department. No test drilled shafts or production shafts shall be constructed until the trial shaft has been evaluated. This evaluation will include review of excavation methods, field construction procedures, and all CSL test results.

814.22 MEASUREMENT.

(a) Drilled Shafts: Drilled shafts shall be measured from the approved tip elevation by the linear foot (lin m).

(b) Trial Shafts: Trial shafts will be measured by the linear foot (lin m) installed.

814.15

(c) Permanent Casing: Permanent casing shall be measured by the linear foot (lin m).

(d) Crosshole Sonic Logging: Crosshole Sonic Logging shall be measured for each drilled shaft tested.

814.23 PAYMENT.

(a) Drilled Shafts: Payment for drilled shafts will be made by the linear foot (lin m) and will include all necessary materials and equipment required for excavating, pumping, furnishing and placing casings, furnishing and placing concrete and reinforcement, removing casings, casings left in place, slurry, slurry testing equipment and performing slurry testing, disposing of slurry, furnishing and installing access tubes for nondestructive testing, any delays due to nondestructive testing schedule, and disposing of excess excavated

material. No payment will be made for concrete required to fill oversized casings or excavation.

Acceptance and payment for concrete drill shafts will be on a lot basis at the contract unit price per linear foot (lin m), adjusted in accordance with the following provisions. A lot will be considered as a continuous identifiable pour that is completed in one day. Multiple shafts poured on the same day but in a non-continuous pouring operation will require separate lots for each identifiable pour. Six cylinders per lot will be tested for compressive strength and in the event of sudden cessation of operation a minimum of three cylinders will constitute a lot. Acceptance and payment for each lot will be made in accordance with Table 901-5 and Note 1. Authorized overruns shall be paid as follows:

1. Payment for shaft lengths in excess of plan length, up to and including 16 feet (5 m) will be made at the contract unit price per linear foot (lin m). When reinforcing splices are required due to increases in shaft length up to and including 16 feet (5 m) the additional deformed reinforcing steel required for splices will be paid for at the contract unit price. No other compensation will be made for increases in shaft lengths up to 16 feet (5 m).

2. Payment for that portion of shaft lengths greater than 16 feet (5 m) will be made in accordance with Subsection 109.04.

(b) Trial Shafts: Payment for trial shafts will be made at the contract unit price per linear foot (lin m) and shall include the cost of CSL Testing. Payment for trial shafts required by the engineer but not specified by the

plans, except when required for acceptance of polymer slurries, will be made in accordance with Subsection 109.04.

(c) Permanent Casing: Payment for permanent casing shall be paid at the contract unit price per linear foot (lin m).

(d) Crosshole Sonic Logging: Payment for Crosshole Sonic Logging testing shall be made at the contract unit price per each drilled shaft tested. Payment shall be for all labor, materials, equipment, and incidentals necessary to perform the required test and furnish the CSL report.

Payment will be made under:

Item No.	Pay Item	Pay Unit
814-01	Drilled Shaft (Diameter)	Linear Foot (Lin m)
814-02	Trial Shaft (Diameter)	Linear Foot (Lin m)
814-03	Permanent Casing	Linear Foot (Lin m)
814-04	Crosshole Sonic Logging (Diameter)	Each

Section 815 Welding

815.01 DESCRIPTION. Welding of structural steel, steel pipe and tubular members, reinforcing steel and aluminum alloys (including qualification of procedures, welders and welding operators, destructive and nondestructive testing, etc.) shall comply with these specifications.

815.02 QUALIFICATION OF PROCEDURES, WELDERS AND WELDING OPERATORS.

(a) General:

(1) The Construction Section shall be the qualifying agency.

(2) Qualifying tests may be made at locations selected by the contractor and approved by the Department. Advance notice of not less than 1 week shall be given to the Construction Section so that the Department can arrange for the presence of the inspector.

(3) Seven copies of the required reports shall be furnished to the Construction Section.

(4) Each welder and welding operator's work shall be identified with a steel stencil.

(5) The social security number and 1 inch by 1 inch (25 mm by 25 mm) passport type picture of each qualifying welder and welding operator shall be furnished. The social security number of the qualified welder and welding operator shall be recorded on the required reports. The qualified welder and welding operator shall have the identification card in their possession when working.

(6) All costs incidental to welding qualifications shall be the responsibility of the contractor.

(b) Structural Steel, Steel Pipe and Tubular Members:

(1) **Structural Steel:** Welding procedures, welders and welding operators shall be qualified in accordance with the latest edition of ANSI/AASHTO/AWS D1.5 (D1.5M) Bridge Welding Code.

(2) **Steel Pipe and Tubular Members:** Welding procedures, welders and welding operators shall be qualified in accordance with the latest edition of ANSI/AWS D1.1 (D1.1M) Structural Welding Code-Steel.

(c) Reinforcing Steel: Welding qualification for reinforcing steel shall comply with the latest edition of AWS D 1.4 Structural Welding Code-Reinforcing Steel.

(d) Aluminum: Welding qualification for aluminum alloys shall comply with the latest edition of ANSI/AWS D 1.2 Structural Welding Code-Aluminum.

(e) Electrodes:

(1) Structural Steel: Electrodes shall be qualified and certified in accordance with the latest edition of ANSI/AASHTO/AWS D1.5 (D1.5-M) Bridge Welding Code.

(2) Steel Pipe and Tubular Members: Electrodes shall be qualified and certified in accordance with the latest edition of ANSI/AWS D1.1(D1.1 M) Structural Welding Code-Steel.

(3) Aluminum: Electrodes shall be qualified and certified in accordance with the latest edition of ANSI/AWS D1.2(D1.2M), Structural Welding Code-Aluminum.

815.03 WELDING. Size, type and length of welds shall be shown on the plans. The use of electroslag and electrogas welding processes will not be permitted.

(a) Structural Steel, Steel Pipe and Tubular Members:

(1) Structural Steel: Welding of structural steel shall comply with the latest edition of ANSI/AASHTO/AWS D1.5 (D1.5M) Bridge Welding Code. All minimum preheat and interpass temperatures in this code that are less than 125°F (50°C) are amended to be a minimum of 125°F (50°C).

(2) Steel Pipe and Tubular Members: Welding of steel pipe and tubular members shall comply with the latest edition of ANSI/AWS D1.1(D1.1M) Structural Welding Code-Steel. All minimum preheat and interpass temperatures in this code that are less than 125°F (50°C) are amended to be a minimum of 125°F (50°C).

(b) Reinforcing Steel: Welding of reinforcing steel shall comply with the latest edition of AWS D1.4 Structural Welding Code-Reinforcing Steel.

(c) Aluminum: Welding of aluminum alloys shall comply with the latest edition of ANSI/AWS D1.2(D1.2M) Structural Welding Code-Aluminum.

815.04 NONDESTRUCTIVE TESTING.

(a) Structural Steel, Steel Pipe and Tubular Members:

814.15

(1) Structural Steel: Non-destructive testing shall comply with the ANSI/AASHTO/AWS latest edition of D1.5 (D1.5M) Bridge Welding Code except that the ends of all groove welds on main members shall be tested with the dye penetrant inspection method.

(2) Steel Pipe and Tubular Members: Non-destructive testing shall comply with the latest edition of ANSI/AWS D1.1(D1.1M) Structural Welding Code-Steel.

(3) Edge Block: Edge blocks shall be used when radiographing butt welds greater than 1/2 inch (13 mm) in thickness. The edge blocks shall have a length sufficient to extend beyond each side of the weld centerline for a minimum distance equal to the weld thickness, but no less than 2 inches (50 mm), and shall have a thickness equal to or greater than the thickness of the weld. The minimum width of the edge blocks shall be equal to half the weld thickness, but not less than 1 inch (25 mm). The edge blocks shall be centered on the weld with a snug fit against the plate being radiographed, allowing no more than a 1/16 inch (2 mm) gap. Edge blocks shall be made of radiographically clean steel and the surface shall have an ANSI 125 μ inch (3.2 μ m) or smoother finish.

(b)Reinforcing Steel: Non-destructive testing shall comply with the latest edition of AWS D1.4Structural Welding Code-Reinforcing Steel.

(c) Aluminum: Non-destructive testing shall comply with the latest edition of ANSI/AWS D1.2 (D1.2M) Structural Welding Code-Aluminum. For sign structures, the dye penetrant method shall be used on butt welds in columns and main chord members, including associated flanges, gussets or main load carrying brackets or members also on fillet welds connecting flanges to main truss chord members.

(d)Personnel Qualification: Persons performing ultrasonic testing shall be qualified by tests administered by the Construction Section, unless otherwise approved.

815.05 MEASUREMENT AND PAYMENT. There will be no direct payment for radiographic inspection, magnetic particle inspection, dye penetrant inspection or other tests as specified.

There will be no measurement or payment made for weld metal deposited; however, there will be no deduction made for removal of metal to be welded due to edge preparation.